

# Interior + Exterior

5  
Years Warranty

Quality Custom Made Blinds + Awnings + Tracks

Exclusive Interior + Exterior Ranges

Extensive Range of Fabrics + Weaves

Motorisation Specialists + Custom Paint

weinor

GRIESSER

SilentGliss

**MEYER BLINDS**  
QUALITY + DESIGN EXCELLENCE | SINCE 1987

# Contact



**Head Office + Showroom:**

25 Richmond Rd, Homebush NSW 2140

**Phone:**

+ 61 2 8762 1900

**FreeCall:**

1 800 254 631

**NZ Phone:**

+ 64 223 556 075

**Email:**

sales@meyerblinds.com.au

**Website:**

meyerblinds.com.au  
weinoraustralia.com.au



**Virtual Showroom:**



## About Blinds by Peter Meyer

Blinds by Peter Meyer began in 1987, built on the experience, craftsmanship and design knowledge that Peter and Helen Meyer developed over 15 years in retail and interior decorating. Their vision was simple: to create premium, custom-made blinds for the trade, with a commitment to quality that would set new standards across the industry.

Over the decades, the company has grown into one of Australia's most highly regarded manufacturers of indoor blinds, curtain tracks, outdoor awnings and technical shading systems. Today, Meyer Blinds is proudly led by Peter and Helen's sons, Simon and Damien, whose combined 60+ years of industry experience continue to drive innovation, service excellence and a deep understanding of the needs of retailers, designers and specifiers.

Our partnerships with leading European brands — including Weinor, Griesser and Silent Gliss — have enabled us to expand our offering with advanced shading systems, architectural curtain tracks and high-performance outdoor solutions. Our products are available throughout Australia, New Zealand and select international markets.

Across all these years, one thing has remained unchanged: our commitment to craftsmanship, exceptional service, and the values Peter instilled from day one.

## Our Founder's Legacy

Peter Meyer, our founder, passed away in 2025, leaving behind a legacy of quality, innovation and genuine care that continues to guide every part of our business.

In honour of Peter, the Meyer family is aiming to raise \$20,000 for Dementia Australia, a cause close to their hearts. If you would like to contribute, please scan the QR code. Every donation, no matter the size, is sincerely appreciated.



# Interior Ranges

## Roller



Meyer Blinds

## Roman



Simply Roman | 14

## Cellular



Simply Cell | 16

## Panel



Moving Panels | 18

## Natural



Urban Weave | 22

## Curtain | Motor



Somfy Tracks | 30

## Curtain | Track



SG | Hand Drawn | 36



Simply Roller | 8



Chinois Eclectic | 24



Silent Gliss Curtains



SG | Recessed | 38



AeroGlide Roller | 10



Le Blinde | 26



SG | 2C Technology | 32



SG | Cord Drawn | 40



Silent Gliss Roller | 12



Silk Road | 28



SG | Motor Tracks | 34



**Curtain | Rod**



**Metropole** | 42

**Venetian**



**Cedar** | 46

**Shutter**



**Timber** | 52

**Skylight**



**Rollers** | 54

**Interior Fabric**

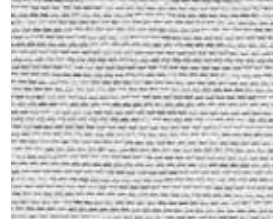

**Signature X** | Web

**Motorisation**



**Somfy** | 116



**Metroflat** | 44



**Habitus Plus** | 48



**Poly** | 52



**Rottezza** | 56

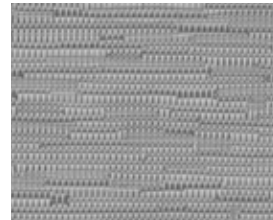

**Basics Collection** | Web



**Automate** | 120



**Aluminium** | 50



**Custom Paint** | 124

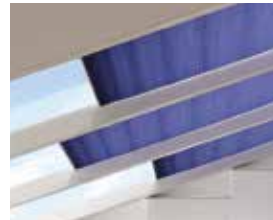

**Simply Cell** | 58



**Simply Naturals** | 20



**Silent Gliss** | 122



**Manhattan** | 50



**SG Wintergarden** | 60



**30 Years**

# Exterior Ranges

## Weinor Awning



Europe's finest range of high quality Awnings + Retractable Roof Systems. Range of 171 designer, 28 sustainable and 56 specialist fabrics. Exclusive to Blinds

## Roller



VertiTex II Zip | 62



VertiTex II Channel | 62



VertiTex II Cable | 62

## Full Cassette



Kubata | 64



Opal II | 66



Smaila | 68

## Full Cassette



Semina Life | 70



Cassita II | 72



I + K + N 2000 | 74

## Semi + Open



Semina | 76



Topas II | 78

## Retractable Roof



Plaza Viva | 80



Plaza Viva + VertiTex II | 80



Pergotex II | 82

## Conservatory



WGM Top | 84



Sottezza Originale | 86



Sottezza Pure | 88



## Option



Paravento Screen | 90



LED Lighting | 90



Tempura Heating | 90



56 Frame Colors | Web

## Solare Teknica



Our range of high quality Outdoor Blinds, Shutters, Venetians and Pivot Arm Awnings, along with the Weinoor range, ensures we have a solution for your every outdoor need.

## Roller | Pivot



T1000 Straight | 100



T2000 Cable | 102



T5000 SRS Zip | 104



T5500 Pivot Arm | 106

## Griesser EVB



Switzerland's finest range of precision External Venetian Blinds, provide optimal solar shading to maintain a comfortable indoor climate control & improve energy efficiency.

## External Venetians



Aluflex® | 110



Solomatic II® | 9112



Lamisol III® | 114

## Outdoor Fabric



Weinoor Fabrics | 92

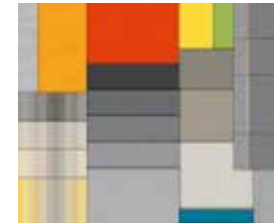

Weinoor Fabrics | 92



My Collections 2 | 92



Special Fabrics | 92



# External

# Simply Roller

SHADE & PRIVACY WITH CLASSIC STYLE



## Basics | Curated quality entry level Roller system

Simply Roller Basics V3 features oval base rails and comes standard with nickel and plastic chains for the ideal entry level system. The Basics fabric selection is curated with affordable pricing for both residential and commercial projects. Featuring motorisation, spring assist, and linking, Simply Rollers are also capable of achieving the smallest fabric gaps.

## Signature | Premium quality Roller system

Stainless steel chains are standard, together with ultrasonically sealed edges and a choice of base bar colours and shapes. The Signature Collection is Australia's largest premier quality fabric range, sourced from the latest fabrics, textures and colours from around the world. Easily motorised, linked, and spring assisted.

### Base Rails:

- 1 | Hem Pocket
- 2 | Oval
- 3 | Oval Fabric Wrapped
- 4 | D Rail
- 5 | Small Designer
- 6 | Deluxe Flat
- 7 | Smart Rail | No Wrap
- 8 | Smart Rail | Half Wrap | Window or Room Side
- 9 | Smart Rail | Full Wrap

## Specifications:

### Maximum Size:

Up to 3000mm Screens + Blockout + Translucent 3000mm

### Styles:

High quality chain driven Rollers with stainless steel, nickel or plastic chain + spring assist

### Fabrics:

Signature + Basics Collection | Sunscreens + Sheers + Recycled + Transluents + Blockouts.

### Privacy:

Varies with the fabric chosen.

### Flame Retardancy:

Many of our fabrics are Flame Retardant.

### Linking:

Three connected systems possible.

### Motorisation:

Highly suitable. **somfy.**



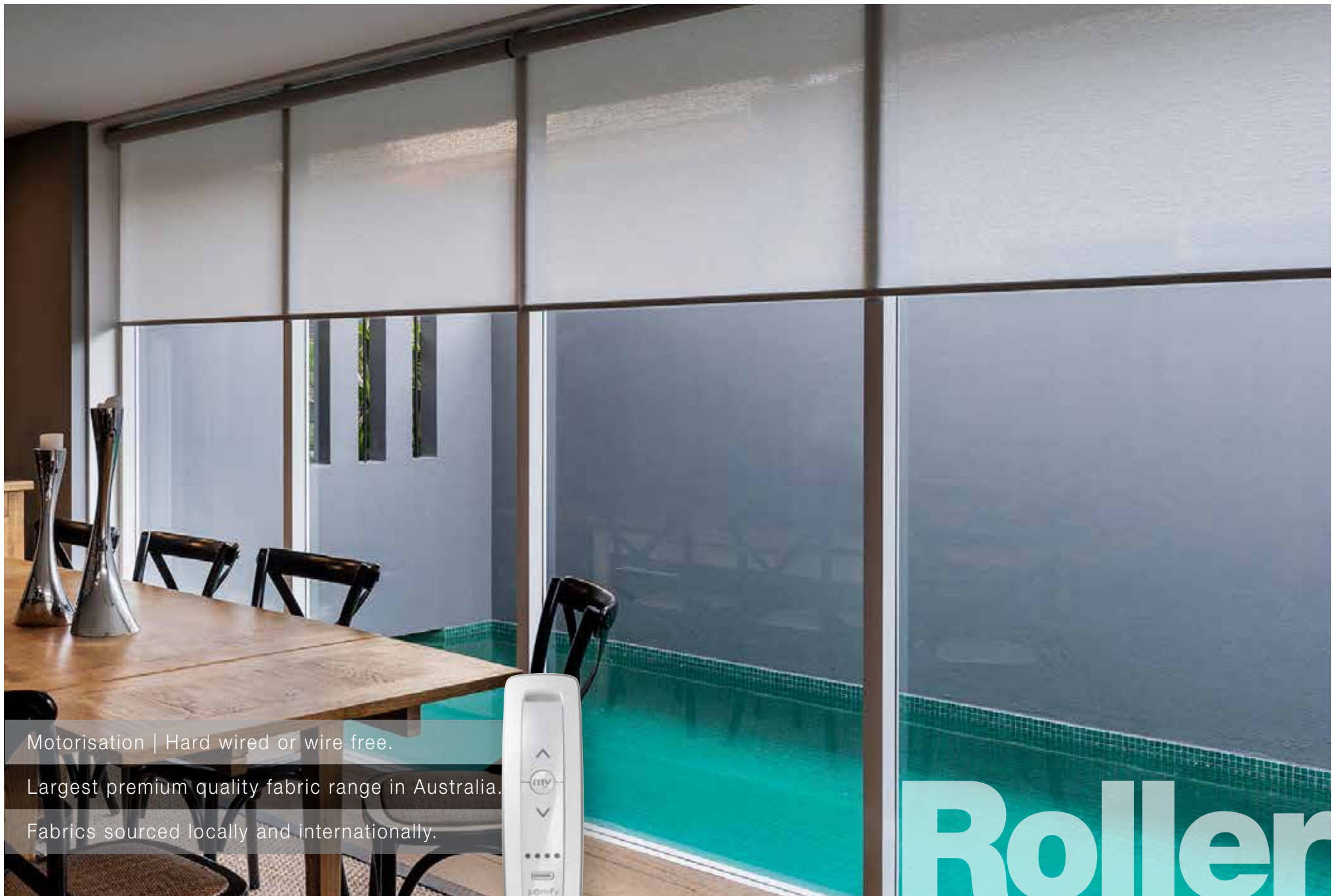

Motorisation | Hard wired or wire free.

Largest premium quality fabric range in Australia.

Fabrics sourced locally and internationally.



# Roller

# AeroGlide™

## PREMIUM CHAINLESS ROLLER BLIND SYSTEM



Introducing AeroGlide™, a chain free child-safe Roller Blind. Effortlessly raise or lower the bottom rail by adjusting it with a touch of the hand to the desired position. The premium minimalist design of the AeroGlide™ has eliminated the need for chains or wand devices.

Easily set top or bottom limits and adjust without having to remove the system. The innovative single-stop limiter protects against over-extending the Roller Blind.

### Specifications:

#### Size:

Maximum width: 2800mm

Maximum drop: 3000mm

Minimum width: 500mm

#### Styles:

High quality cordless

#### Fabrics:

Signature + Basics Collection | Sunscreens + Sheers + Translucents + Blockouts.

#### Privacy:

Varies with the fabric chosen.

#### Flame Retardancy:

Many of our fabrics are Flame Retardant.

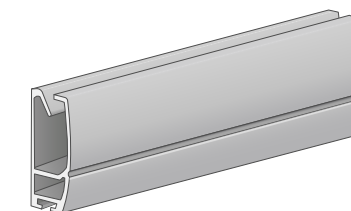
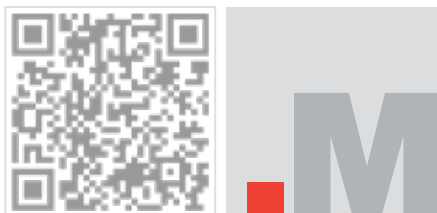

### AeroGlide | Base Rail:

D Rail + Optional: D Rail w. Sound Dampener

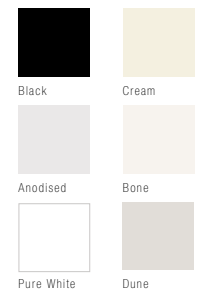

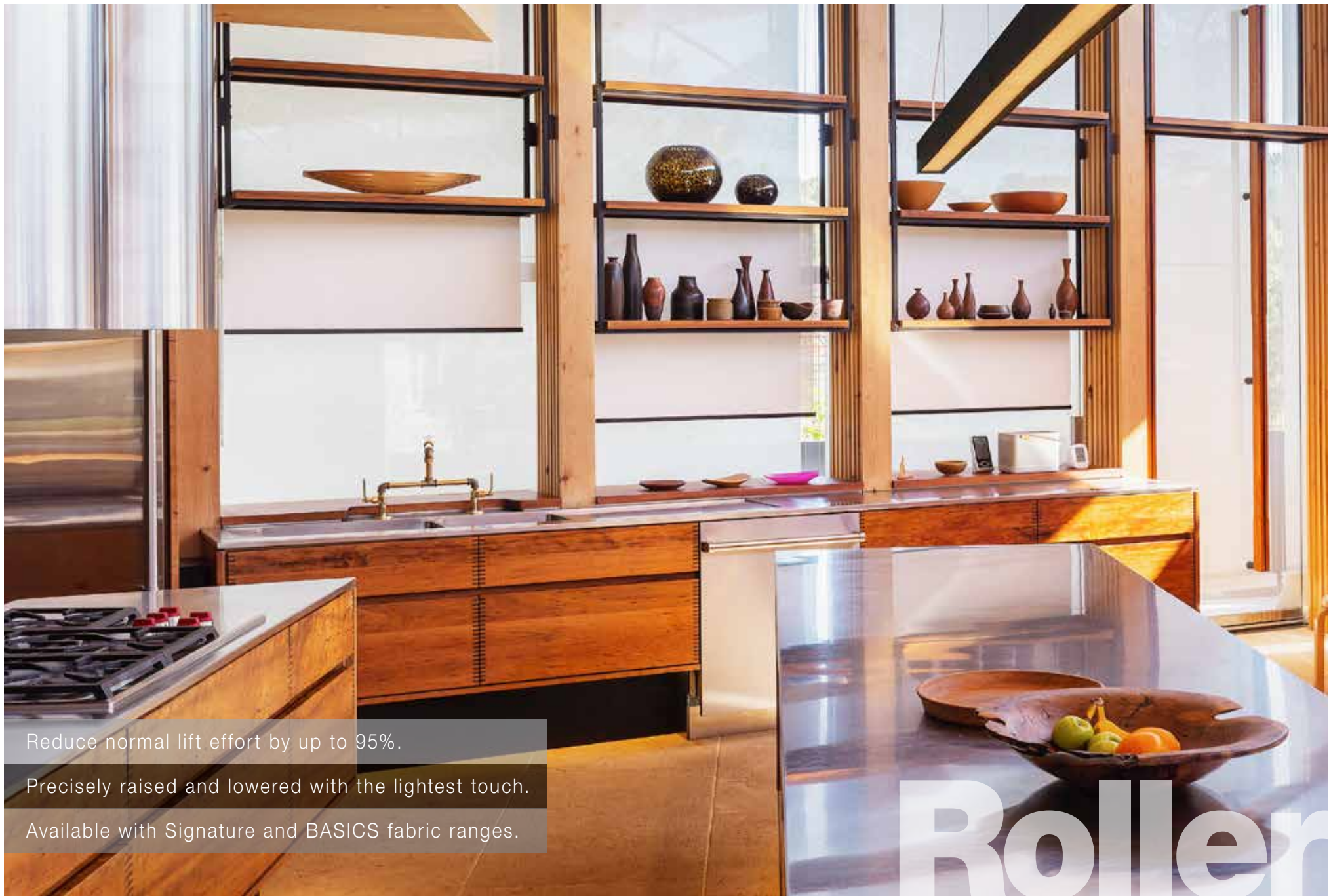

Reduce normal lift effort by up to 95%.  
Precisely raised and lowered with the lightest touch.  
Available with Signature and BASICS fabric ranges.

# Roller

# Silent Gliss Roller



PREMIUM HEAVY DUTY ROLLER SYSTEM | SG4930 CHAIN DRIVE + SG4970 MOTORISED

Now manufacturing Silent Gliss Roller Blinds in Australia, we offer customers high quality and technically advanced heavy duty Roller Blind systems at a more attainable price point. These incredibly hard working Blinds can be supplied up to a massive 3.4m wide + 5m drop, and are designed to be powerful with a super smooth, planetary geared chain operation.

## Specifications:

### Maximum Size:

Light Filtering: Up to 3400mm wide x 5000mm drop.  
Screens + Blockout: Up to 3200mm wide x 5000mm drop.

### Styles:

Heavy duty chain operated Rollers w. planetary gear drives or motorised solution.

### Fabrics:

Signature + Basics Collection | Sunscreens + Sheers + Translucents + Blockouts.

### Privacy:

Varies with the fabric chosen.

### Flame Retardancy:

Many of our fabrics are Flame Retardant.

### Linking:

Two connected systems possible.

### Motorisation:

Highly suitable.  
Hard Wired + Wire-Free options available. 

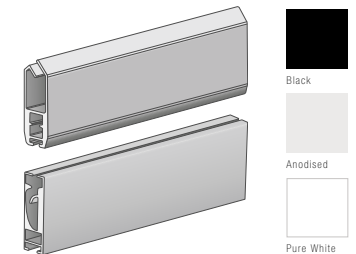

**SG Premium | Base Rails:**  
1 | Large Designer  
2 | Deluxe Flat [ std ]

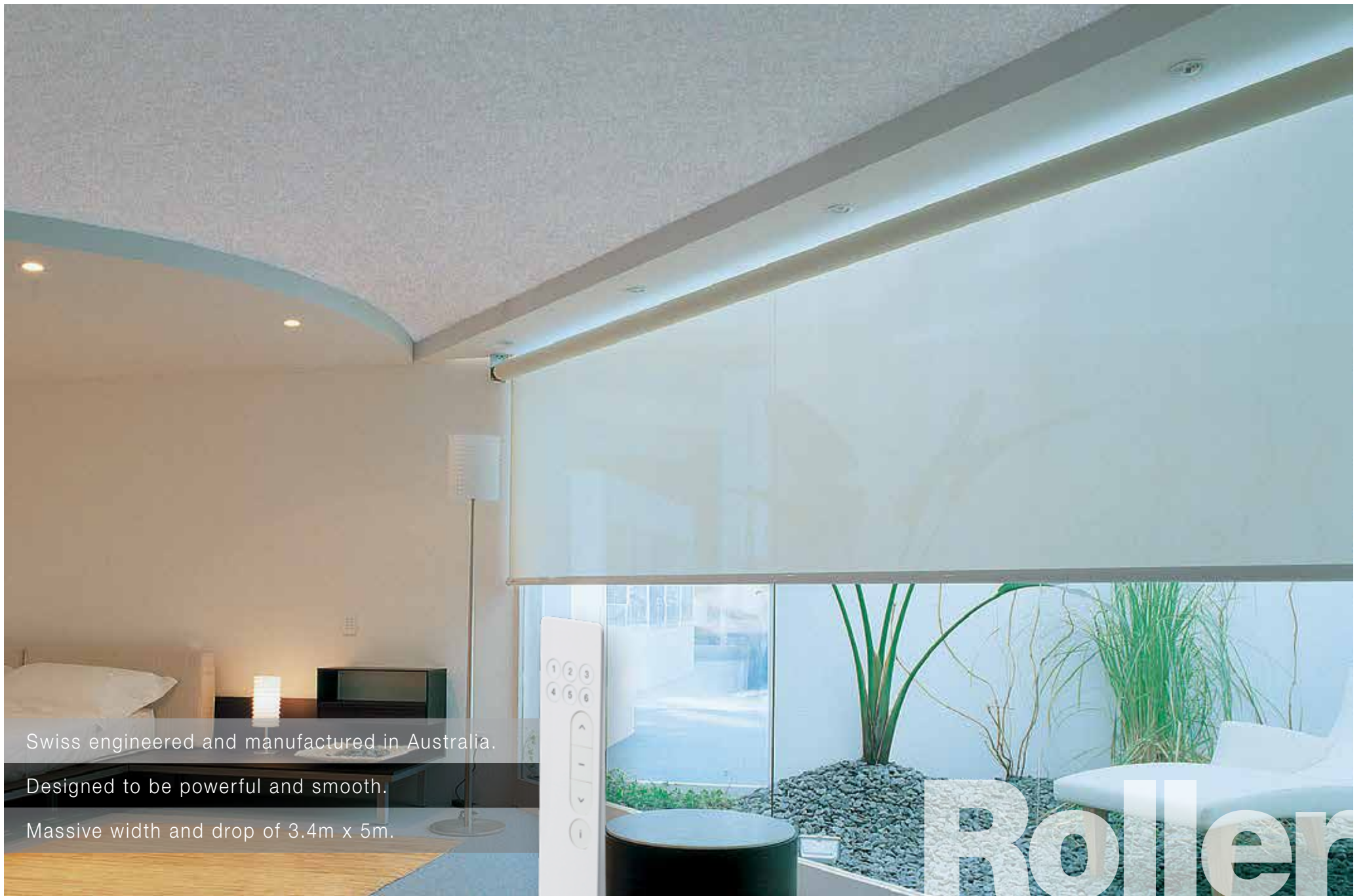

Swiss engineered and manufactured in Australia.

Designed to be powerful and smooth.

Massive width and drop of 3.4m x 5m.

Roller

# Simply Romans

TIMELESS, ELEGANT AND CLASSIC STYLE



Simply Romans are custom made to the highest quality and will add classic style and presence to any décor. They offer excellent insulation and small side gaps. When raised, they form their own elegant pelmet and can be supplied with or without timber battens. Available in screen, translucent or blockout, allowing for heat, light, and privacy control with a blockout or light filtering effect. They can be used alone or with Curtains, or fitted inside or outside the window recess.

We offer an extensive selection of fabrics, weaves, colours & textures, to provide designers, architects and decorators the opportunity to create truly unique window treatments that will enhance any commercial or residential building style. Our quality & attention to detail truly sets our Simply Roman Blinds apart.



## Specifications:

### Maximum Size:

Up to 3350mm depending on fabric choice.

### Styles:

Conventional folds on 40mm fabric wrapped headrail with pockets at about 280mm.

Cord operation with premium cordlock as standard.

### Fabrics:

Sunscreens + Sheers + Transluents + Blockouts.

### Privacy:

Varies with the fabric choice.

### Insulation:

Excellent.

### Flame Retardancy:

Many of our fabrics are Flame Retardant.

### Motorisation:

Highly suitable with Classic headrail. 



Aluminium Battens  
Back



Timber Battens  
Front



Stitched Pocket  
Back



Front Pelmet  
Optional End Covers

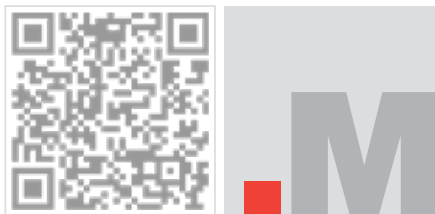



Versatile | Suits all architectural styles.  
Excellent insulation and small side gaps.  
Classic headrail with motorisation option.

# Roman

# Simply Cell

SLIM & MINIMAL DESIGNER LOOK | ENERGY SAVING WITH STYLE



Simply Cell offers Australia's largest range of energy efficient Honeycomb Blind fabrics in a variety of innovative systems including Pre-tensioned, Free Hanging, Cordless & Motorised Options, Shaped and Skylight systems. Small stack heights also makes the 20mm designer Blinds ideal for small recesses or as a perfect addition to reduce light coming through Shutters.

## Specifications:

### Maximum Size:

Sizes vary. Please refer to the website via QR code.

### Styles:

Cord and chain operated, Pre-tensioned hand or wand operated, Top down/Bottom up, Day/Night, Skylights, difficult window shapes, F-Touch (cordless option) and motorised.

### Fabrics:

Over 190 Transluents, Blockouts + Sheers. Privacy varies with fabric choice.

### Privacy:

Varies with the fabric choice.

### Insulation:

Excellent.

### Motorisation:

Highly suitable. **somfy.**

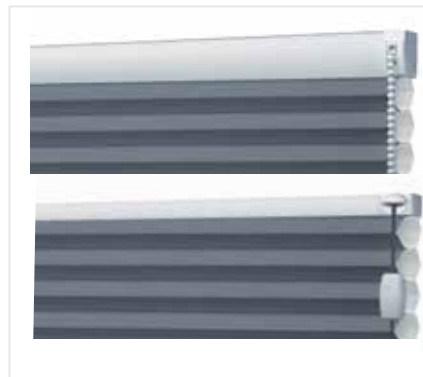



Cleverly designed Pre-tensioned system with cordless operation.

Highly innovative Free Hanging system with patented cordlock.

Skylights and Shaped systems for roofs and unusual windows.

# Cellular



# Moving Panels

STYLE + FUNCTION + FLEXIBILITY

A very unique and stylish Moving Panel system.

Manufactured to the highest quality standards, Our Moving Panels are extremely versatile, enabling a wide range of configurations providing stylish and elegant solutions for most décors and architectural styles. Offers a wide range of functional and unique design opportunities for both residential and commercial applications. We pair a number of our exclusive fabrics and natural weaves to create very unique Panel Blinds.



## Specifications:

### Tracks:

3, 4 and 5 channel Track available.

### Operation:

Wand operated:

### Track Colours:

White, White Birch, Anodised + Black.

### Panel Sizes:

Width divided by number of tracks, add 70mm overlap approx.

We recommend a maximum Panel width of 1000mm.



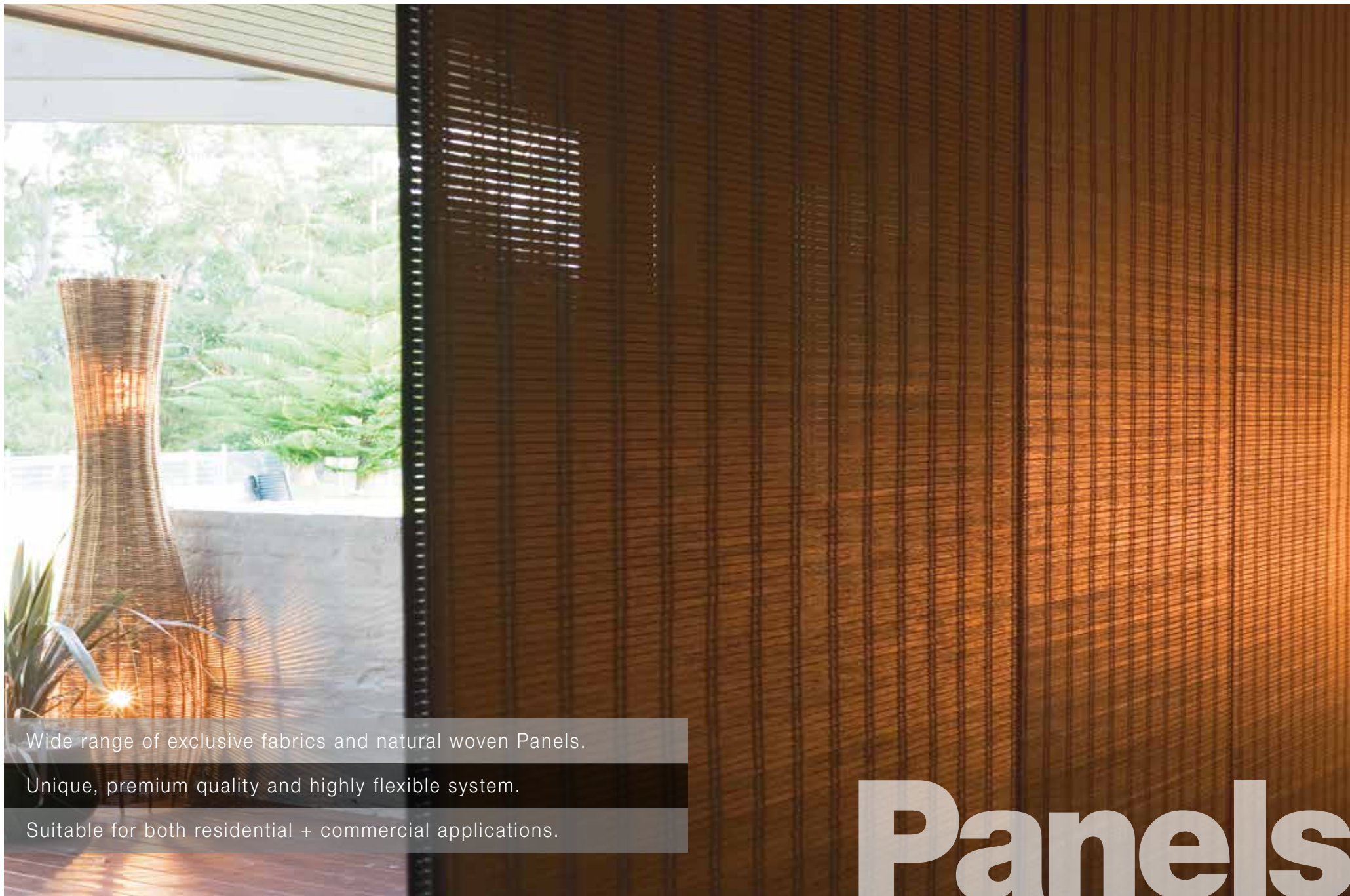

Wide range of exclusive fabrics and natural woven Panels.

Unique, premium quality and highly flexible system.

Suitable for both residential + commercial applications.

# Panels

# Simply Naturals



## Le Blinde

Timeless French Timber Weaves



Nice



Nice Mocha



Avignon\* I Priv



Avignon Mocha\* I Priv



Chateau I Priv.



Chateau Mocha I Priv.



Le Washe 006



Lyon



Orleans



Custom Colour



\*Limited Stock

## Chinois Eclectic

Exotic Oriental Bamboo Weaves



Matchstick



Dusk

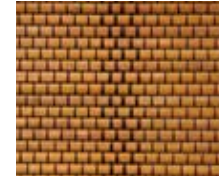

Earth



Night

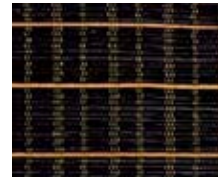

New Forest

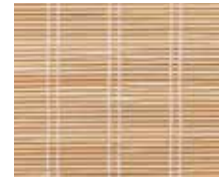

Shinju



Reed



Stone



Java



Wintergrass

### Natural motorisation

Add functionality to any natural fabric Roller or Roman Blind with cutting edge Somfy technology.



### Website samples

View large samples of our exclusive Simply Naturals ranges.



## Silk Road\*

Rustic + Exotic Oriental Weaves



Adana



Damascus



Taxila



Soparo



Khotan



Aden



Niya



Hoi Ann



Sudak



Shandan



Lanzhou



Korkai



Nantong



Goa

\* 3 Year Warranty

## Urban Naturals

Stylish Natural City Chic Weaves



High Rise



Galleria



Open Plan



Urbis



Manhattan



Vogue



Greenwich



Tribeca

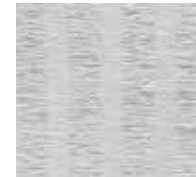

Soho

## Fusion

On Trend Fabric Weave



Silver Thread

# Naturals



# Urban Weave

## STYLISH NATURAL WEAVES | CHIC DESIGN STYLES

Urban Weave is a stylish natural-look fabric range. It has been designed exclusively for Blinds by Peter Meyer in Australia and has been specified by designers and decorators for a range of homes from stylish prestige, city chic through to simple beach side retreats.

Urban Weave has superb translucent qualities and is available in Romans, Rollers & Moving Panels. We've recently added 3 new trend weave colours to the range which has become an extremely popular selection due to its natural look and texture.

The weave offers around 90% UV blockage and has great heat retention. Front battens are available on Romans and naturally all Roller Blinds, Roman Blinds and Moving Panel Blinds are suitable for motorisation.

### Specifications:

#### Maximum Size:

Roman Blinds – 3000mm wide x 3000mm drop (joined panels).  
Roller Blinds – 1800mm wide x 3000mm drop.

#### Styles:

Romans, Roller Blinds + Moving Panels.

#### Weaves + Privacy:

A stunning selection of natural weaves.  
Privacy depends on fabric choice.

#### Thermal Properties:

99% UV Blockage. Good heat retention and reflection – about 75%  
Composition: 32% Polyester/68% Polypropylene.

#### Motorisation:

Highly suitable. **somfy.**



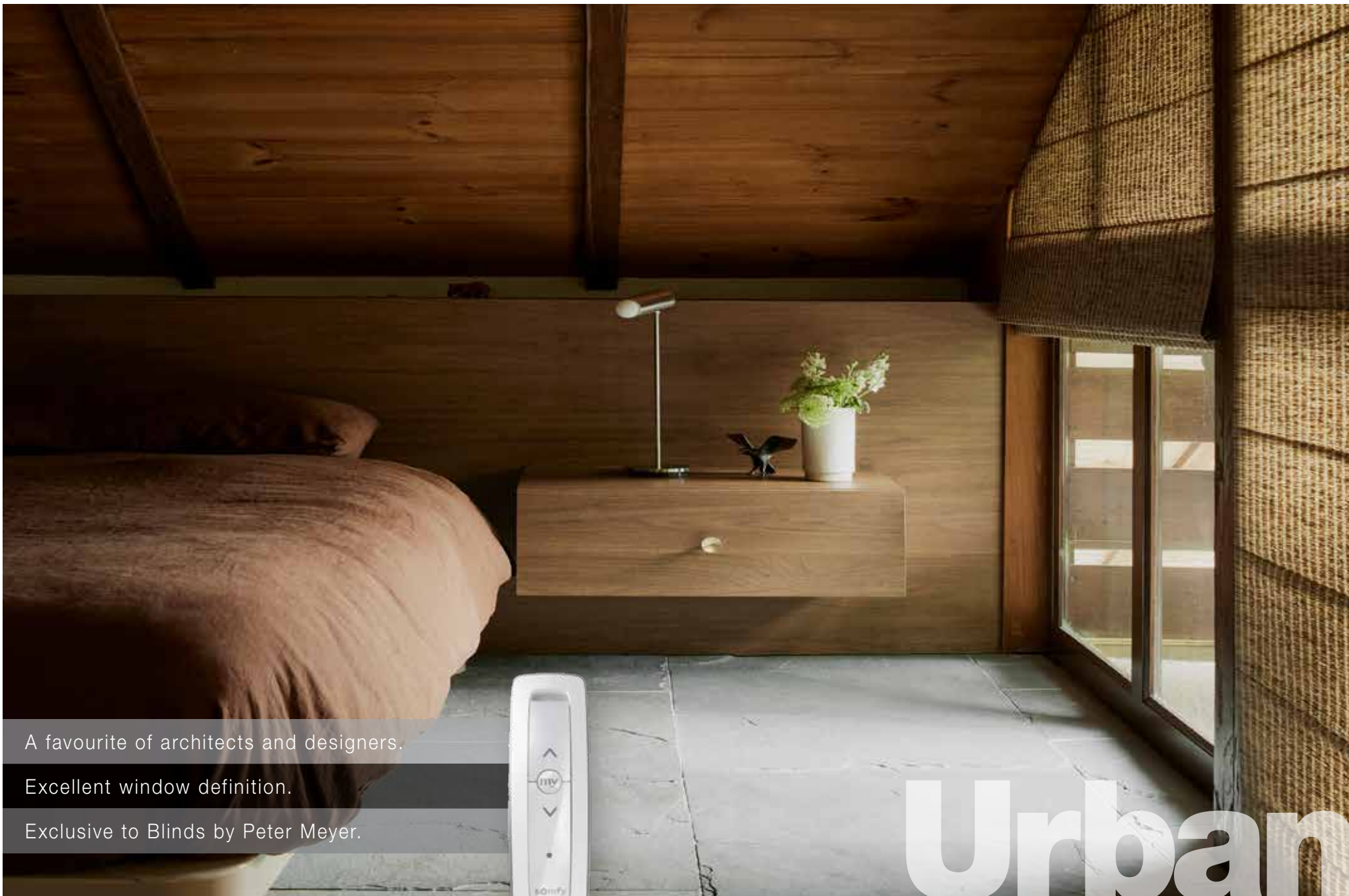

A favourite of architects and designers.

Excellent window definition.

Exclusive to Blinds by Peter Meyer.



# Urban



# Chinois Eclectic

## BAMBOO WEAVES | EXOTIC ORIENTAL

These ten exotic oriental weaves were developed & created especially for us. They can create an outstanding feature or add that finishing touch to any environment. The Chinois Eclectics collection will provide mystique and elegance, but with a difference.

Suitable for domestic and commercial applications Chinois is hand crafted using bamboo, seagrasses, jutes and other reeds and woven together using a polyester yarn to ensure durability and longevity. This product has the most stunning window definition.

*"I always wanted to give the best designers a challenging weave that just said 'use me'... I've found it with this Chinois Eclectics collection"..... Peter.*

### Specifications:

#### Maximum Size:

Most weaves are 2500mm wide.

Note: some larger weaves may be heavy.

#### Styles:

Romans, Roll-ups, Curtains + Moving Panels.

#### Weaves + Privacy::

10 exotic weaves selected for their individual charm.

None of the Chinois range will give sufficient privacy for a bedroom at night although they do provide daytime privacy.

#### Finishes:

All natural finishes. Some can be clear lacquered or custom painted.

#### Thermal Properties:

Bamboo is one of nature's best insulators. UV protection will vary proportional to openness of weave as will insulation and light transmission.

#### Motorisation:

Highly suitable. **somfy.**

Romans most suitable.

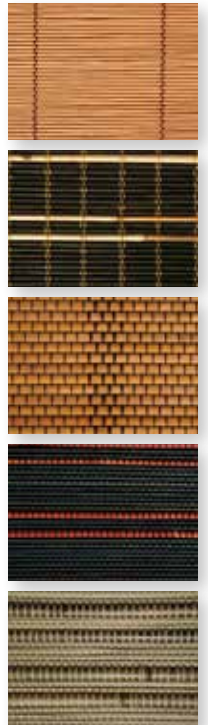



Handwoven exotic bamboo, seagrasses, jutes and reeds.

Wide range of natural and eclectic weaves.

Exclusive to Blinds by Peter Meyer.



# Chinois

# Le Blinde

## FRENCH TIMBER WEAVES | HANDCRAFTED AND TIMELESS



Our Le Blinde French woven timber fabrics will add a timeless element to any decór. Handcrafted for over a century by France's finest woven timber craftsmen exclusively for Blinds by Peter Meyer.

These woven timbers can be made into Roman Blinds, Roll-up Blinds or Moving Panel Blinds. They can be used in their beautiful natural state or stained to your requirements or even custom painted to colour match your design palette.

We also bias bind the edges of our Woven Timber Blinds to give them a finish that will last the test of time. Naturally our woven timber can be made in manual cord operated, chain operated or motorised. Enhance your residential or commercial space with our selection of Le Blinde woven timber blinds.

Le Blinde, is actually the first range that Blinds by Peter Meyer started producing. Peter wanted to offer the finest timber weave ranges in the world, so he selected premium hand woven timber weaves from France from a company who had been making them since 1872. To this day, Le Blinde is installed in some of the finest homes in Australia and New Zealand.

### Specifications:

#### Maximum Size:

2500mm wide x 3000mm drop. Prefinished fabrics max: 2400mm width.

#### Styles:

Romans, Roll-ups, Curtains + Moving Panels.

#### Weaves + Privacy:

9 Weaves in total. 6 Natural, 3 Le Finishe [ 2 Le Washe + 1 Stain ], Three weaves are designed to give privacy. All others give daytime privacy while allowing you to see out. This reverses at night.

#### Thermal Properties:

Timber is one of nature's best insulators. UV protection will vary according to openness of weave as will insulation and light transmission.

#### Finishes:

Natural, clear lacquer, custom painted or stained.

#### Motorisation:

Highly suitable. **somfy.**





Introduced in the 1870's, enjoying a resurgence in popularity.

Available natural, custom stained or custom painted.

Exclusive to Blinds by Peter Meyer.



# Le Blinde



# Silk Road

## RUSTIC ORIENTAL WEAVES | UNSTRUCTURED NATURAL BEAUTY

Traditionally woven rustic weaves, our Silk Road fabrics are created by blending natural harvests from oriental grasslands, woodlands, and riverbanks.

Entirely unique, Silk Road brings an unmatched stylish natural beauty to a variety of decorating styles. Each fabric, made from a diverse array of naturally harvested grasses and botanicals, is a unique work of nature's art. All Silk Road Blinds are carefully hand loomed, taking up to 3 days to weave one unique 15m fabric roll.

Naturally, all Blinds are totally individual and carefully planned so that the pattern is repeated to work in multiple Blinds, whilst ensuring the natural uniqueness inherent in each of the individual Blinds.

Silk Road is a very special collection of exotic fabrics and is totally exclusive to Blinds by Peter Meyer.

### Specifications:

#### Styles:

Roman Blinds, manual + motorised options.

#### Fabrics:

16 exotic weaves selected for their individual charm and qualities

Privacy: Varies with the fabric chosen.

The beauty of this range is that you can choose to leave it beautifully sheer or simply line it with a translucent lining for privacy. If you want the Blinds to darken the room, simply line them with a blackout lining. This makes the range so versatile it can be used throughout the whole house including bedrooms!

#### Motorisation:

Highly suitable. 

#### Warranty:

3 Years.

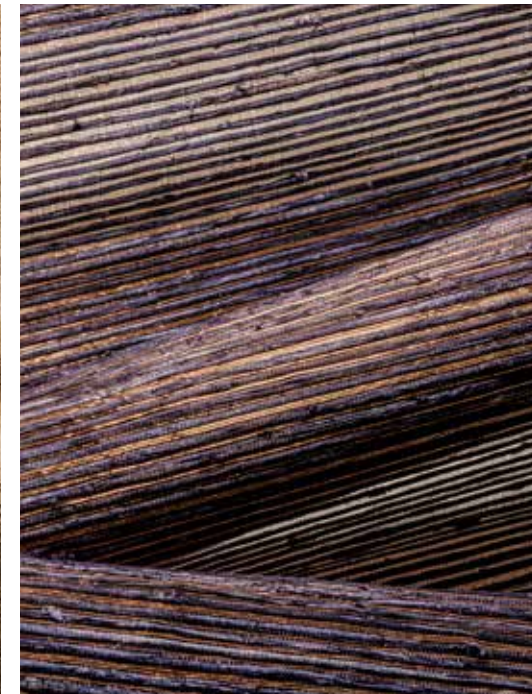



100% unique works of art with rustic weaves.

A 15m roll takes 3 days to weave by hand.

Exclusive to Blinds by Peter Meyer.



# Silk Road

# Somfy Tracks

## GLYDEA® + MOVELITE MOTORISED CURTAIN TRACKS



### Somfy Glydea® Ultra

Somfy's newest innovation to motorised Curtains, the Glydea® Ultra is one of the quietest Curtain motorisation solutions on the market. Glydea® Ultra is discreet with light, fluid movement and a strong traversing capacity up to 60kg. Perfect for residential and commercial projects where creating the right ambience via a simple touch of the button is important.

### Somfy Movelite

An accessible and elegant Curtain motorisation alternative to Glydea® Ultra, the Movelite 35 offers significant cost savings. This entry level motor combines French style and advanced engineering. The Movelite 35 range includes three motors capable of lifting up to 35kg, available in RTS, Wirefree RTS, and WT with the option to convert to DCT motor. These motors work with Glydea® Ultra Track and accessories and are ideal for all Curtain types.

### Specifications:

Medium to heavy duty.  
Standard or wave headings.

### Options:

Bendable in both directions. 300mm minimum radius.  
Top, face or extended face fixing. Direct fixing through the track profile is also possible.  
Maximum width of up to 12m.  
Maximum Curtain weight of up to 60kg.

### Motorisation:

Movelite motors operate up to 35kgs and Glydea® Ultra has lifting capacities of up to 35kg and 60kg.



Movelite 35

Glydea Ultra





Cutting edge Curtain Track technology.

Glydea® Ultra up to 60kg lifting capacity.

Wire-free options available with Movelite.



# Glydea

# Silent Gliss 2C Technology

## SOUND OF SILENCE



Silence just got even quieter with the new Silent Gliss 2C technology. The 2C Gliders + 2C Rollers are manufactured using a hard component which ensures stability and a soft 'filling' to absorb and quieten operating noise. Combining the 2C Rollers & 2C Gliders with the specially coated Silent Track, allows Curtains to move smoothly and silently.

**Hand + cord operated Curtain Tracks** | Combine their coated Silent Track with premium **2C Gliders**.

**Motorised Curtain Tracks** | Combine the new coated Silent Track with premium, patented **2C Rollers**.



**Quiet Mark.** Silent Gliss has earned the prestigious Quiet Mark certification for their high-performance products that effectively reduce noise pollution in homes. This certification acknowledges the underestimated detrimental effects of excessive noise on health and well-being. Silent Gliss joins the forefront of the Quiet Mark movement, advocating for responsible acoustic design and striving to reduce noise pollution globally.

### Specifications:

Medium to heavy duty.  
Standard or wave headings.

#### Options:

Bendable in both directions. 80mm minimum radius on certain tracks (SG6465). Recess, top, face or extended face fixing.  
Direct fixing through the track profile also possible.

#### Motorisation:

Maximum width of up to 25m.  
Standard and powder coat colours available.





Cutting edge patented technology.

Swiss precision manufacturing expertise.

Quiet Mark certified.

# Silence

# Silent Gliss Motorised Curtain Tracks



## SILENT + HIGH PERFORMANCE

The SG 5600 Motorised Curtain Track provides benchmarking technology based on outstanding Swiss innovation which meets the complex demands of modern architecture. Offering unparalleled silence due to a perfect combination of the 2C heavy duty Rollers, the exclusive high-performance motor, and the specially coated Curtain Tracks. Our in-house Curtain Track bending specialists ensure motorised Tracks are professionally bent to meet unique design preferences and needs.

### Specifications:

Medium to heavy duty.  
21 cm/sec opening/closing speed.  
2C Roller technology.

### Options:

Standard or wave headings (60mm or 80mm glider spacings avail.)  
Bendable in both directions. 250mm minimum radius.  
Top, face or extended face fixing.  
Direct fixing through the track profile is also possible.  
Flush recess mounting possible when using recess profile #10862.  
Maximum width of up to 25m.  
Maximum Curtain weight of up to 65kg.  
Standard and powder coat colours available.  
Motor colour options available in White, Silver and Black (new).



Silent Gliss has earned the prestigious Quiet Mark certification for their high-performance products that effectively reduce noise pollution in homes



Silent Gliss has earned the prestigious Quiet Mark certification for their high-performance products





High-performance motor | 65kg lifting.

Quiet Mark certified.

Patented 2C Rollers for unprecedented silence.

# Motor



# Silent Gliss Hand Drawn Curtain Tracks

## SMOOTH + REFINED DESIGN

The Silent Gliss Hand Drawn Curtain Tracks are unobtrusive, elegant and have smooth operation. The most economical and simple to use and inherently safe by design, these hand drawn Curtain Tracks suit a large variety of installations. With standard or wave options, they are durable and maintenance free and can be bent at an angle or continuously curved.

### Specifications:

Light to heavy duty.  
2C Glider and 2C Roller technology.

### Options:

Standard or wave headings (60mm or 80mm glider spacings avail).  
Can be flush ceiling mounted.  
Bendable in both directions.  
Face fix via Smart Fix brackets which include unique magnetic covers to hide fixing screws.  
Some options can be recessed.  
Optional direct fixing through the profile.  
Tracks can be joined together for extended lengths.  
Standard and powder coat colours available.



Silent Gliss has earned the prestigious Quiet Mark certification for their high-performance products that effectively reduce noise pollution in homes

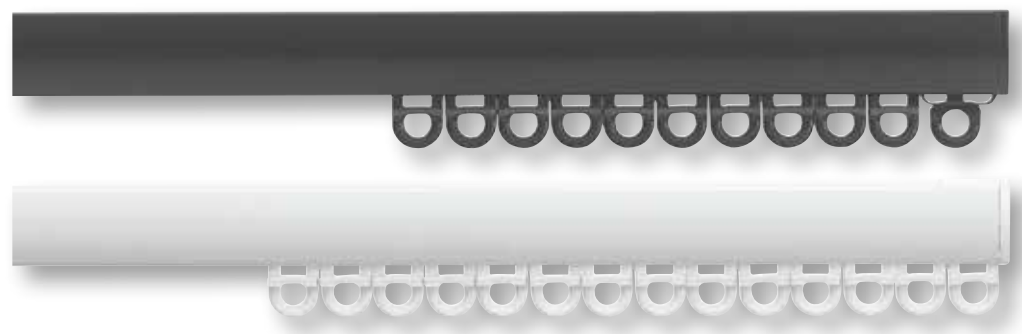



Elegant and smooth operation.

2C Glider technology for unprecedented silence.

In-house bending service.

# Hand



# Silent Gliss Recessed Curtain Tracks

SILENT + UNOBTRUSIVE

Silent Gliss Recessed Curtain Tracks can be hand drawn or motorised, providing a sleek and unobtrusive appearance for floor to ceiling elegance. The 2C Glider technology allows for smoother and quieter curtain movement, ensuring a pleasant and noise-free experience while maintaining privacy and light control. Available in standard and wave options.

## Specifications:

Light to heavy duty.  
2C Glider technology

## Options:

Standard or wave headings (60mm or 80mm glider spacings available).  
Recessed tracks are available in direct fix or held in place with wedges.  
Can be flush ceiling mounted when paired with matching recessed profile.  
Bendable in both directions.  
Tracks can be joined together for extended lengths.  
Standard and powder coat colours available.



Silent Gliss has earned the prestigious Quiet Mark certification for their high-performance products that effectively reduce noise pollution in homes





Integrates seamlessly into ceilings.

2C Glider technology for unprecedented silence.

In-house bending service.

# Recess

# Silent Gliss Cord Drawn Curtain Tracks

5  
Years Warranty

SILENT + FLEXIBLE

The SG 3840 Cord Operated Curtain Track offers a touch-free solution, eliminating the need to handle the Curtain fabric directly. It is suitable for various Curtain weights, including heavier and long drop and inaccessible Curtains. The elegant design ensures smooth operation and complies with Australian child safety standards. In addition to standard and wave options, bending is also available in both directions (reverse bending).

## Specifications:

Max track length of 6m.

Medium to heavy duty.

2C Glider technology.

## Options:

Standard or wave headings (60mm or 80mm glider spacings available).

Ideal in a top fix situation as it looks the same from both sides with no visible fixings.

Bendable in both directions

Brackets available for top, face or extended face fixing.

Face fix via Smart Fix brackets which include unique magnetic covers to hide fixing screws.

Child safe. Complies fully with all Australian Safety Standards.

Standard and powder coat colours available.



Silent Gliss has earned the prestigious Quiet Mark certification for their high-performance products that effectively reduce noise pollution in homes





Elegant and smooth operation.

2C Glider technology for unprecedented silence.

Heavy duty, touch-free Curtain Track solution.

Cord



# Silent Gliss Metropole Curtain Rod

## ROUND PROFILE + DESIGNER FINIALS

An alternative to traditional Curtain Rods, the Metropole is in a class of its own. With a unique design that eliminates the need for Curtain Rings, it offers smooth and silent operation with patented 2C Gliders and 2C Rollers. Available in a 30mm round profile with standard flush and stud end caps in a variety of colours and optional custom powder coats and decorative finials.

The Silent Gliss Metropole finials are optional decorative elements that fit on at the end of the Curtain Rod. The epitome of style and elegance, they deliver the perfect finish to the Metropole. With a wide range of designer styles, colours, and finishes available, there is a finial to suit any aesthetic - whether it be minimalist design or a bold statement.

### Specifications:

Hand operated.  
Medium to heavy duty.  
2C Glider technology

### Options:

Standard or wave headings (60mm or 80mm glider spacings available).  
Fitting: Ceiling or wall. Also suitable for hanger rods.  
Face fix via Smart Fix brackets which include unique magnetic covers to hide fixing screws.  
Matching end caps and bracket covers.  
Optional decorative finials.  
Bendable in both directions.  
Standard and powder coat colours available.



Silent Gliss has earned the prestigious Quiet Mark certification for their high-performance products that effectively reduce noise pollution in homes





Innovative design. No need for Curtain Rings.

2C Glider and Roller technology for unprecedented silence.

Optional decorative finials.

Rod



# Silent Gliss Metroflat Curtain Rod

## DESIGNER FLAT CURTAIN ROD

A 36mm designer flat profile Curtain Rod Track system, engineered to work without Curtain Rings, the Metroflat is the sister product to our Metropole Curtain Rod system. It incorporates the same innovative 2C Glider technology that ensures the smoothest, most silent operation available. Fitted to the wall or ceiling, it has matching flush or stud endcaps. Metroflat is also suitable to use as cubical tracking for hanger rods.

### Specifications:

Hand operated.  
Medium to heavy duty.  
2C Glider technology.

### Options:

Standard or wave headings (60mm or 80mm glider spacings available).  
Standard end or flush end cap.  
No optional finials available.  
Fitting: Top fix, face fix, hanger rod and end fix.  
Face fix via Smart Fix brackets which include unique magnetic covers to hide fixing screws.  
Matching flush or stud end caps.  
Bendable in both directions  
Standard and powder coat colours available.



Silent Gliss has earned the prestigious Quiet Mark certification for their high-performance products that effectively reduce noise pollution in homes





Elegant and versatile.

Contemporary flat design.

2C Glider and Roller technology for unprecedented silence.

Rod

# Cedar Venetians

## PREMIUM QUALITY NATURAL TIMBER VENETIANS



Blinds by Peter Meyer manufacture Australia's finest custom made natural Cedar Venetian Blinds. The Cedar used is sustainably harvested with three new trees being planted for every tree removed, with the grain consistent and fine. Our specially selected 4.2mm thick blades can be custom painted, stained or lacquered.

We do this in our own paint booths where we are able to control every stage of production guaranteeing quality. Assembly is by hand with every slat being meticulously checked at every stage of the process. Fingertip control, convenience and functionality is easily added to the enjoyment of Timber Venetians by incorporating Somfy's cutting edge innovation and whisper quiet motorisation technology.

### Specifications:

#### Natural Timber Venetians:

Slats: Canadian Western Red Cedar | 46mm + 60mm + 85mm slat width | 4.2mm slat thickness.

#### Finishes:

Custom painting, clear lacquer, stained + clear oiled.

#### Recommended Size:

Up to 4m<sup>2</sup> | larger by arrangement.

#### Motorisation:

Highly suitable.

### Custom paint specialists. Colour + Stain + Finishes.

Over 35 years experience with custom paint, stains and finishes. Specialist colour matching.



Premium Thickness

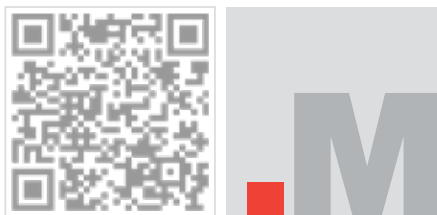
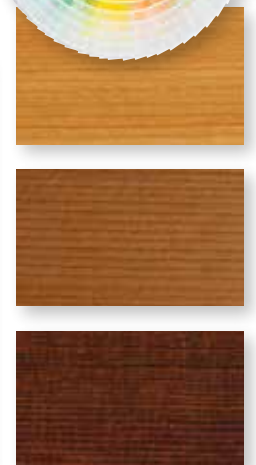

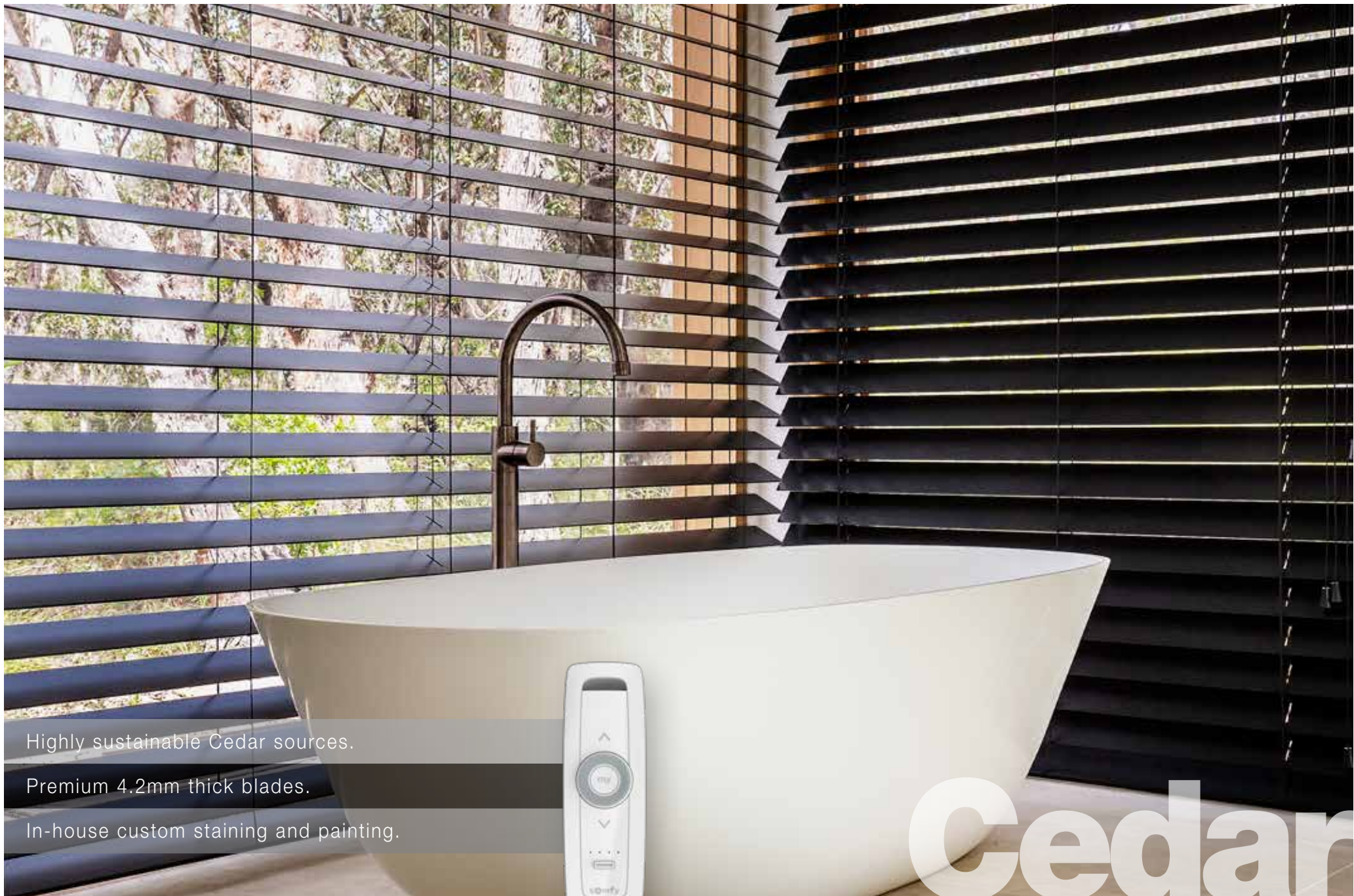

Highly sustainable Cedar sources.

Premium 4.2mm thick blades.

In-house custom staining and painting.

# Cedar



# Habitus® Plus | Timber + Poly Venetians

DESIGNER STYLE. QUALITY POLY + TIMBER VENETIANS

Combining on-trend Poly colours with sustainably grown Basswood Timber colours, this light weight range is perfect for a modern interior décor. For a sleek contemporary look, all Timber colours are available in both 50mm and 63mm slat widths. Poly 50mm are available in an array of colours with 63mm reserved for the most popular Poly colours (Alpine White & Warm White). Plus for modern styling, Habitus Timber has an 80mm wide flat fascia and Habitus Poly has an 83mm wide Moulded fascia. Habitat Poly is available in 2700mm and the Habitus Timber can go to 3000mm wide. The 3000mm slat width means even the widest windows can be covered using this natural, lightweight Venetian.

## Specifications:

### Habitus® Poly:

100% Polystyrene materials. Co-extruded polymers, impervious to moisture.

### Habitus® Timber:

Made from sustainably sourced Basswood.

### Habitus® Timber Sizes:

**Slat** | 50mm + 63mm x 3mm | To 3000mm wide

**Fascia** | Flat | 80mm x 7 mm | To 3000mm wide

**Max. Blind Size** | 3000mm\* 3000mm ( max.4sqm )

### Habitus® Poly Sizes:

**Slat** | 50mm + 63mm x 3.2mm | To 2700mm wide

**Fascia** | Moulded | 83mm x 8mm | To 2700mm wide

**Max. Blind Size** | 2400mm\* 3000mm ( max.4sqm )

### Acorns:

Quality natural timber acorns are used on all Timber and Poly blinds.

### Head Rail:

Standard: Premium quality, heavy duty head rail and locking system.

### Finish:

Quality finish. Mitred corners on valance. No visible raw ends on the slats.

All ends are painted to colour match.

**Motorisation:** **somfy.**



### Timber | 50mm + 63mm



Gunmetal



Mist

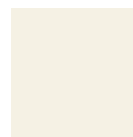

Champagne

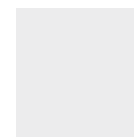

Quartz

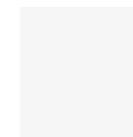

Glacier

### Poly | 50mm

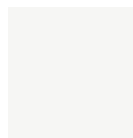

Alpine White

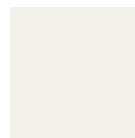

Warm White



Karri



River Teak



Ironbark

### Poly | 63mm

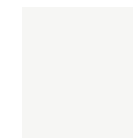

Alpine White

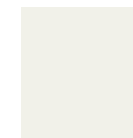

Warm White





Venetians with style | Tough & very affordable.  
Sustainably grown Basswood Timber.  
Habitus Poly is approx. 15% lighter than PVC alternatives.



# Premium



# Aluminium Venetians

25MM + 50MM ALUMINIUM + UNIQUE 50MM ALLOY & CEDAR COMBINATION

## Aluminium Venetians

Combining elegant simplicity with practical versatility and function. They bring a high level of minimalist and on trend style to most architectural directions. The wide range of metallics and designer colours together with a choice of a slim 25mm wide or classic 50mm wide slat provides designers, architects and decorators with a wide range of unique design solutions.

## Manhattan Venetians

Our custom made Manhattan Venetians combine rich Canadian Western Red Cedar fascias and baserails with a stylish combination of premium 50mm crowned Aluminium slats, in a range of designer colours with colour co-ordinated ladder string. Optional wide textile ladder tape can also add another design flair. The Cedar is offered in finishes including clear lacquer, custom stains and paints together with a standard range of classic complimentary colours. Manhattans are unique to Blinds by Peter Meyer.

The look and feel of Manhattan Blinds ranges from extremely modern & urban slick to classic 'retro', depending on the installed environment.

## Specifications:

### 25mm Aluminium Venetians:

#### Maximum Sizes:

Maximum Width: 3000mm  
Maximum Height: 3000mm  
Maximum Area: 6m<sup>2</sup>

### 50mm Classic Aluminium Venetians:

#### Maximum Sizes:

Maximum Width: 3200mm  
Maximum Height: 3300mm  
Maximum Area: 10m<sup>2</sup>

### Manhattan | 50mm Aluminium + Cedar Venetians:

#### Maximum Sizes:

Maximum Width: 3200mm  
Maximum Height: 3300mm  
Maximum Area: 10m<sup>2</sup>

#### Motorisation:

Highly suitable. **somfy.**

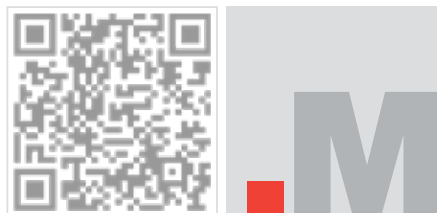



Minimalist design and practical functionality.

Sustainable Cedar fascias and baserails.

Exclusive to Blinds by Peter Meyer.

# Designer



# Plantation Shutters

HIGH QUALITY, STYLISH & ENERGY-EFFICIENT. OPTIMAL LIGHT CONTROL & PRIVACY.

## Our Plantation Shutter Collection:

We offer a stunning selection of high-quality Plantation Shutters designed to elevate any space. Whether you're seeking the natural beauty of Cedar, the durability of Basswood, or the practicality of Poly, our range of Shutters offers solutions for every space and budget. Explore our collection for the perfect Plantation Shutters for your home or business.

### Premium Western Red Cedar Plantation Shutters:

Crafted from premium Western Red Cedar with classic chamfered edges & elliptical blades, these Shutters are sustainably sourced and boast natural insulation properties

### Western Red Cedar Plantation Shutters:

Our Western Red Cedar Shutters are crafted from premium-quality sustainable wood, ensuring durability and a versatile natural aesthetic to match your decor.

### Premium Basswood Plantation Shutters:

The perfect balance of affordability, durability and functionality with our stylish Premium Basswood Plantation Shutters. Available with choice of designer flat or elliptical blades.

### Poly Smart Plantation Shutters:

Moisture resistant, they are ideal for high-traffic and wet areas. Our Poly Smart Plantation Shutters are reinforced with Aluminium cores for added durability. Both practical and affordable.

## Specifications:

### Premium Western Red Cedar:

**Blades:** Elliptical | 63mm + 76mm + 89mm + 114mm.

**Finish:** Painted + Stained + Lacquered + Oiled + Custom Colours.

### Western Red Cedar:

**Blades:** Elliptical | 47mm + 63mm + 76mm + 89mm + 114mm.

**Finish:** Painted + Stained + Lacquered + Oiled + Custom Colours.

### Premium Basswood:

**Blades:** Elliptical or Flat | 63mm + 89mm + 114mm.

**Finish:** Standard Stained + Standard or Custom Painted.

### Poly Smart:

**Blades:** Elliptical | 63mm + 89mm + 114mm.

**Finish:** Painted + Custom Light Colours.

**Fit:** All Shutters | Hinged + Bi-fold + Sliding.





Wide range of premium quality Timbers + blade widths

Extensive choice of custom finishes. Paints + stains + naturals.

Total control over your light + privacy.

# Shutters

# Skylight Rollers

## TOTAL SUN CONTROL

We specialise in custom high quality Skylight Roller Blind systems for both domestic and commercial use, providing total sun control while assisting building insulation. Our options include sun and light filtering to complete blackout, with manual or motorised operation available.

Skylight Blinds are essential in the hotter months in Australia as they can effectively cut out excess glare, light and heat from the sun. In Winter, Skylight Blinds also help keep warmth in. Our expert staff can advise you on the most appropriate system for your needs.





Significant energy savings.

State of the art Skylight technology.

Manual and motorised operations.



# Skylight

# Sottezza Skylight + LED

## UNDERMOUNTED SKYLIGHT SYSTEM

This Undermount Skylight Roof system is designed to mount flush under a sloping or flat roof and can be used in large scale skylight windows providing the ultimate interior heat protection. Sizes up to 6m width and 5m projection are possible. An amazing solution for the most beautifully designed architectural skylights and glass roofs. Running on a minimum of 0°-45° pitch allows both designer profiles, Sottezza Pure + Sottezza Originale to cover large projections.

The OptiStretch technology makes for taught fabric without the traditional light gaps of other solutions. By far one of the most advanced Undermount Roof systems on the market, German design and quality with integrated LED lights, Sottezza showcases Weinor's world leading German technology.

### Specifications:

#### Installation Under Glass

##### Maximum Width:

6m

##### Maximum Projection:

5m

Max. Fabric m<sup>2</sup>

Stretch | 24m<sup>2</sup> Opti | 30m<sup>2</sup>

##### Pitch Angle:

0° - 45°

##### Options

OptiStretch | Tempura Infrared Heating

##### Colours:

Frame: 56 frame colours, with access to over 210 powder coat colours.

##### Standard Fabric:

171 Acrylic + Polyester solution dyed fabrics including 28 sustainable options.

##### Motorisation:

Highly suitable. **somfy.**

5 Years Warranty



Sottezza Pure | LED



Sottezza Originale | LED



Honoured 2018



Chicago Athenaeum Museum  
of Architecture and Design



Up to 6m width and 5m projection.

2 Designer profiles + Opt Integrated LED lighting.

OptiStretch taut fabric technology.

# Sottezza a Skylight

# Simply Cell Skylights

## HONEYCOMB BLIND SYSTEM



Our Simply Cell range, made in Germany is an energy saving designer Honeycomb Blind system. It offers over 190 highly insulating Honeycomb fabrics, including a variety of colours, designs, and textures. With four main model types, our compact Simply Cell Skylight systems provide an impressive range of options to meet the needs of both residential and commercial customers.

### Options:

**DF Skylight can be used to fit both Velux and Fakro Skylight windows as well as made to measure windows.**

**DF 20** | With side channels and operating from bottom up and top down.

**DF Comfort 20** | With slightly larger side channels and an operating handle that can attach an operating rod.

**DF Comfort 30** | Operates bottom up top down with side channels. Ability to house two fabrics on the one window, such as a blackout and translucent.

**Our PL range can all span up to 1500mm wide x 3500mm in projection.**

**PL 11** | The entry level offering operated via hand or wand.

**PLK 13** | Crank operated.

**PLE 12** | Top of the range motorised. Controlled by either a remote control or home automation system.

### Motorisation:

Highly suitable. **somfy.**

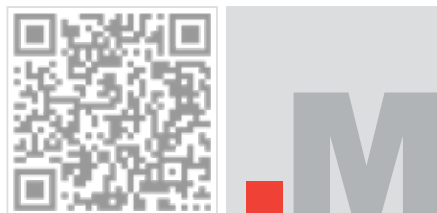



German quality design + manufacturing.

Over 190 insulating Honeycomb fabrics.

Shaped, Sloped and Velux Skylight windows.



# Skylight

# Silent Gliss Wintergarden

## GUIDED ROMAN BLINDS



Timeless & elegant, Wintergarden combines premium side guide profiles with an extensive range of soft-folding fabric panels in on trend colours & designs. Innovative & highly functional, Wintergarden provides shading solutions to compliment both domestic & commercial skylights, glass roofs, atriums and conservatories. Demand for Skylights and Wintergarden systems continues to increase due to modern architecture's use of larger expanses of glass to maximise natural daylight & views.

### Specifications:

Crank or motorised.

Light to large duty.

#### Maximum Width:

Single 2500mm - 3000mm | 15m<sup>2</sup> - 18m<sup>2</sup> (up to 6000mm - Triple system).

#### Max Projection:

6000mm. (Total 15m<sup>2</sup> - 36m<sup>2</sup>).

Maximum Fabric: Up to 25kg.

#### Options:

Fitting: Ceiling, wall or recessed if motorised.

#### Features:

Bendable, sloping.

#### Linking:

2 crank connected systems or 3 motorised possible.

#### Fabrics:

Silent Gliss fabric collection. Sheer + Screen + Translucent + Dim Out.

#### Motorisation:

Highly suitable.





Premium side guide profiles.

Extensive range of soft-folding fabric panels.

Innovative & highly functional design.

# Wintergarden

# VertiTex II



EXTERIOR ROLLER BLINDS. THE ONLY 75MM CASSETTE. SMALL & DISCREET.

This stylish Vertical Roller Blind range features tiny 75mm and 92mm cassettes in Cable & Channel versions that can span a massive 6m width with up to a 4m drop. The 92mm and 112mm Zip version enables blinds to span up to 6m width with drops up to 3m.

Available in 2 sleek architectural profiles, square + round, adapting unobtrusively to all building facades. The patented Weinor Opti-Flow System® ensures the fabric position is always perfect. VertiTex II avoids bulky cassette housings on patios, windows and balconies. Unique cantilever guide rail mounts allow Blind installation up to 2.5m wide without cassette brackets.

For windows, VertiTex II is a suitable alternative to external shading systems or Roller Shutters and can be used inside and outside. A wide range of fabric types will allow you to filter light and privacy to suit your needs. For every application and facade, VertiTex II can provide the solution. VertiTex II throughout its wide range of closures & profiles is small, discreet and so versatile.

## Specifications:

### Fabrics:

VertiTex systems pair with Weinor's unique & exclusive fabric ranges.

Cable + Channel: Screens by Weinor | GlassFibre | StarScreen | Soltis 86 | Soltis 92 | My Collections 2 - Acrylic & Poly

### Cable + Channel:

Screens by Weinor | GlassFibre | StarScreen | Soltis 86 | Soltis 92 | My Collections 2 - Acrylic & Poly

### Zip:

Screens by Weinor | GlassFibre | StarScreen | My Collections 2 - Acrylic & Poly

### Colours:

Frame: 56 frame colours, + 210 powder coat colours..

### Motorisation:

Highly suitable. **somfy**.



Zip | Wind Resistant



75mm | 92mm | 112mm Square



Side Channel | All Purpose



75mm | 92mm | 112mm Round



Cable | Light delicate look



Patented Opti-Flow System®.





Smallest 75mm cassettes on the market.

Shades + protects large areas to 6m width.

German precision and patented Opti-Flow System



# VertiTex II



# Kubata + Kubata LED

FOLDING ARM AWNING | FULL CASSETTE | MINIMAL CUBIC DESIGNER STYLE.

Kubata's crisp, minimal cubic cassette shape provides an exceptional style element for the most contemporary of facades. The award winning design incorporates the latest technology and premium German components. Its durable and quiet LongLife arm, optional LED spot lights and a range of colour and fabric options, Kubata is a perfect addition to any outdoor living space.

## Specifications:

### Awning Profile Dimensions [WxH]:

210mm x 205mm

### Maximum Width:

7m

### Maximum Projection:

4m (At 6.5m width)

### Maximum Size:

7m x 3m or 6.5m x 4m

### Wind Rating:

Beaufort I 5

### Pitch Angle:

5° - 40°

### Colours:

Frame: 56 frame colours, + 210 powder coat colours.

### Standard Fabric:

171 Acrylic + Polyester solution dyed fabrics including 28 sustainable options.

### Motorisation:

Highly suitable. **somfy.**





Minimal, cubic style with no visible fixings.

Cutting edge award winning design.

German innovation and precision quality.



# Kubata



# Opal II + Opal II LED

FOLDING ARM AWNING | FULL CASSETTE | SHADING LARGE AREAS

Our Opal II Cassette Awning stands out for its timeless, classic design hand in hand with groundbreaking Weinor technology. Made to shade large areas, it blends in harmoniously with its surrounding architecture. The attractive shape of the 172mm high cassette adds a sophisticated element. A wide range of tempting and practical optional extras make it easy to operate and wonderfully convenient while also extending its lifetime.

The Opal II and Opal II LED Awnings have been carefully designed to provide the highest quality Folding Arm Awning system to shade and extend usage for large patios, outdoor entertainment and dining areas.

Our Opal II Awnings offer a wide range of options to enhance functionality and extend outdoor living hours including, increased shading with Valance Plus, integrated LED lighting & Tempura infrared heating integrated into the profiles. Covering large areas is achieved by linking Awnings up to a massive 12m wide. The wall connect profile will stylishly and discretely seal the Awning back to the wall.

## Specifications:

### Awning Profile Dimensions [WxH]:

Opal II + LED: 265mm x 172mm

Opal II Valance Plus LED: 326mm x 165mm (Valance Plus LED)

### Maximum Width:

12m

### Maximum Projection:

4m

### Valance Plus Max Size:

5m x 3.5m or 6m x 3m

### Wind Rating:

Beaufort I 5

### Pitch Angle:

5° -40° | 7° -40° (From 3600mm projection)

### Colours:

Frame: 56 frame colours, + 210 powder coat colours.

### Standard Fabric:

171 Acrylic + Polyester solution dyed fabrics including 28 sustainable options.

Motorisation: **somfy.**

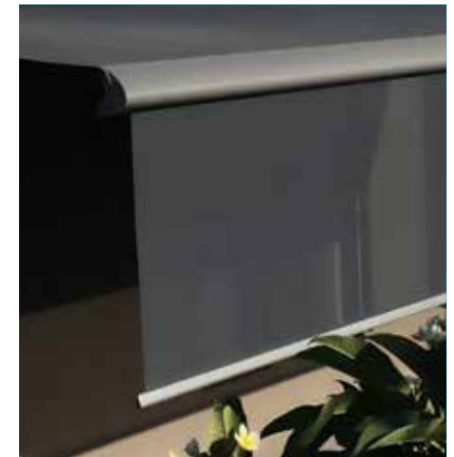

product design award

2014

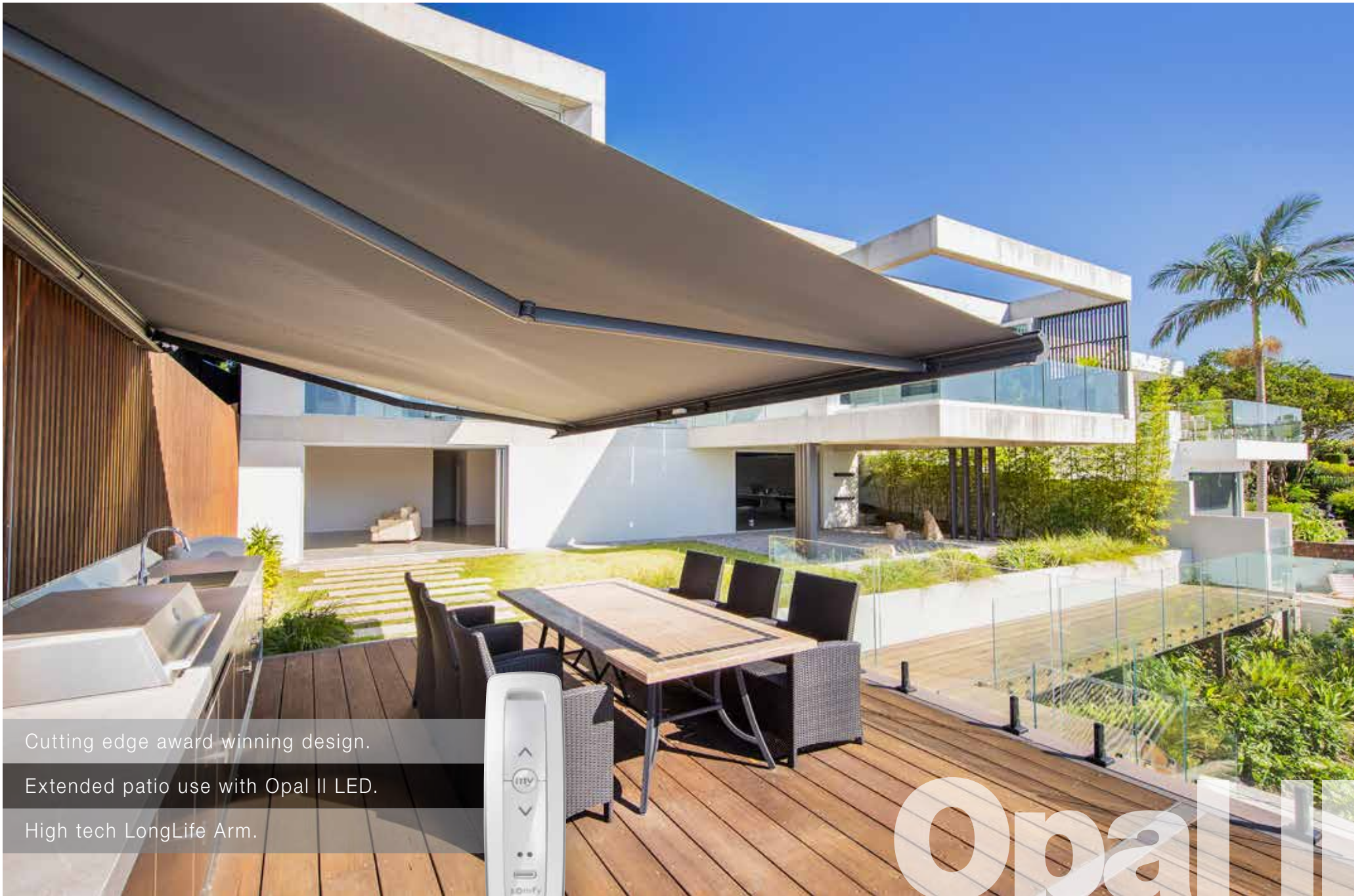

Cutting edge award winning design.

Extended patio use with Opal II LED.

High tech LongLife Arm.



# Opal II

# Smaila + Smaila LED



FOLDING ARM AWNING | FULL CASSETTE | MINIMAL CUBIC DESIGNER STYLE.

With a sleek cubic design and decorative side end caps, our Smaila Awning offers a distinctive look with stylish side end caps in five attractive colours. Smaila is a combination of the best features in our Awnings range, including the LongLife arm and Opti-Flow-System® that ensure perfect fabric positioning. It can be easily installed on a wide variety of surfaces and cover a large area with ease. Smaila LED offers 30,000 hours of energy-efficient lighting and is designed to blend seamlessly into the cassette for a pleasing glow even when retracted.

## Specifications:

### Awning Profile Dimensions [WxH]:

248mm x 155mm ( Incl. Std. Bracket )

### Dimension: with Valance Plus:

306mm x 155mm

### Maximum Width:

5.5m (with 3m max. proj.)

### Maximum Projection:

3.5m (with 5m max. width)

### Maximum Size:

5.5m x 3m or 5m x 3.5m

### Wind Rating:

Beaufort 5

### Pitch Angle:

5°-40° | Valance Plus: 10°- 20°

### Operation:

Motorised or Crank | Valance Plus Crank only

### Install Alternatives:

Walls, Ceilings + Rafters

### Wall Seal Profile:

Eliminates gap between awning and wall.

### Colours:

Frame: 56 frame colours, + 210 powder coat colours.

### Standard Fabric:

171 Acrylic + Polyester solution dyed incl 28 sustainable.

### Motorisation: **somfy**.





Minimal, cubic style with no visible fixings.

Cutting edge award winning design.

German innovation and precision quality.



# Smaila

# Semina Life + LED



FOLDING ARM AWNING | FULL CASSETTE | DESIGN EXCELLENCE

Semina Life is a very versatile Full Cassette Awning combining a crisp stainless steel aesthetic with Weinor's cutting edge technology and German precision build quality. With an exceptional price-performance ratio, the Semina Life is a serious alternative to a semi-cassette. The elegant design will enhance residential or commercial architectural styles from modern to traditional.

Awarded Europe's prestigious Red Dot for design, innovation, excellence & build quality. The innovative styling's unique, modern cassette with aluminium rings create a visual highlight that enhances the combination of frame color + fabric design. Now evolved as a timeless design classic.

Features include Weinor's renowned Longlife Arm, highly functional cassette with muffled feed rollers that ensure maximum protection from the elements with almost no Awning wear. Options include integrated LED Lights, Valance Plus and integrated Tempura Quadra Heaters to extend outdoor living hours. Semina Life is Weinor's most stylish, cost effective and feature rich Awning.

## Specifications:

### Awning Profile Dimensions [WxH]:

307mm x 194mm + 367mm x 194mm Valance Plus

### Maximum Width:

6.5m

### Maximum Projection:

4m

### Valance Plus Max Size:

5m x 3.5m or 6m x 3m crank or 6m x 3.5m motorised.

### Wind Rating:

Beaufort | 5

### Pitch Angle:

5° -25°

### Colours:

Frame: 56 frame colours, + 210 powder coat colours.

### Standard Fabric:

171 Acrylic + Polyester solution dyed fabrics incl. 28 sustainable options.

### Motorisation:

Highly suitable. **somfy.**



reddot award 2016  
best of the best



Cutting edge award winning design.

Excellent price performance ratio.

High tech LongLife Arm.



# Semina Life

# Cassita II + Cassita II LED

FOLDING ARM AWNING | FULL CASSETTE



With its slim, purist design, the Cassita II is in perfect harmony with modern home interior trends. Despite its ultra-slim design, the cassette is packed with a whole range of technological innovations. The minimalist look of the two-point installation system underlines the contemporary design. Its dimensions make the Cassita II the ideal sun protection system for most patio sizes. Cutting edge design combined with German precision and technology has seen the Cassita II and Cassita II LED awnings win a range of European product & design awards.

The clever two-point suspension adds to the Cassita II's stylish and minimal appearance. The fabric and frame are well protected from wind and rain in the 12cm flat oval cassette. Available width to 5.5m and with a maximum projection of 3m. The Cassita II LED model extends the hours of outdoor enjoyment on the patio. Now available with infill profile to fill the gap between the end fix bracket for a seamless wall connection.

## Specifications:

### Awning Profile Dimensions [WxH]:

266mm x 155mm

### Maximum Width:

5.5m

### Maximum Projection:

3m

### Wind Rating:

Beaufort | 5

### Pitch Angle:

5° -45°

### Colours:

Frame: 56 frame colours, + 210 powder coat colours.

### Standard Fabric:

171 Acrylic + Polyester solution dyed fabrics including 28 sustainable options.

### Motorisation:

Highly suitable. **somfy.**





Cutting edge award winning design.

Extended patio use with Cassita II LED.

High tech LongLife Arm.



# Cassita II

# I + K + N 2000

## FOLDING ARM AWNING | FULL CASSETTE + NICHE FLUSH FACADE MOUNT

The IK2000 is Weinor's tried and tested classic Cassette Awning range. Available as an I2000 without back plate for level building facades or as the K2000 with back plate for uneven bases the sturdy Weinor Awning with back bar support system can be used almost anywhere. As the detail on the front rail and end caps suggest, the IK2000 leans toward a more traditional style.

The highly functional N2000 is an Awning designed especially for niche fixing. With its unique flat front rail the Awning disappears almost completely into the facade. The N2000 offers simple, minimalist style with crisp flush face mount.

### Specifications:

#### Awning Profile Dimensions [WxH]:

200mm x 211mm I/K2000

210mm x 180mm N2000 + Recess space req. 210mm x 197mm

#### Maximum Width:

6m I N2000 [ 1xSect.] + 12m I/K2000 [ 2xSect.]

#### Maximum Projection:

3.5m I N2000 + 4m I/K2000

#### Wind Rating:

Beaufort I 5

#### Pitch Angle:

5° -40°

#### Colours:

Frame: 56 frame colours, + 210 powder coat colours.

#### Standard Fabric:

171 Acrylic + Polyester solution dyed fabrics including 28 sustainable options.

#### Motorisation:

Highly suitable. **somfy.**



5 Years Warranty

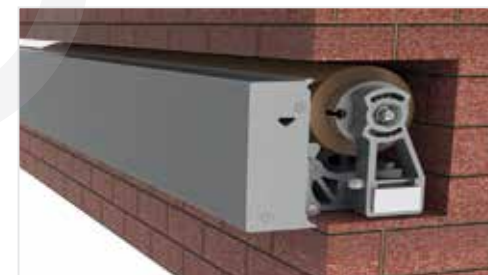



Blends seamlessly into the facade  
3 cassette variants. Highly versatile.  
Multi section options for wide patios.



# N 2000

# Semina + Semina LED

FOLDING ARM AWNING | SEMI CASSETTE



Semina combines a fresh, youthful design with proven technology and reliable quality. The semi-cassette provides for protection of fabric and technology ensuring exceptionally long service life. The semi-circular housing profile together with a large front profile ensures the fabric and mechanism are protected from the elements and remain free from dirt.

## Specifications:

### Awning Profile Dimensions [WxH]:

204mm x 204mm

### Maximum Width:

7m

### Maximum Projection:

3.5m

### Wind Rating:

Beaufort | 5

### Pitch Angle:

5° -40°

### Colours:

Frame: 56 frame colours, + 210 powder coat colours.

### Standard Fabric:

171 Acrylic + Polyester solution dyed fabrics including 28 sustainable options.

### Motorisation: **somfy.**

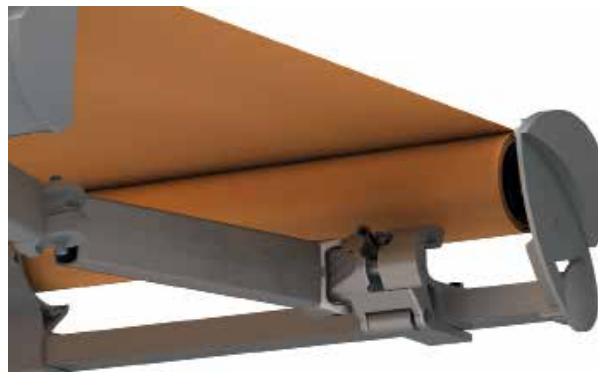
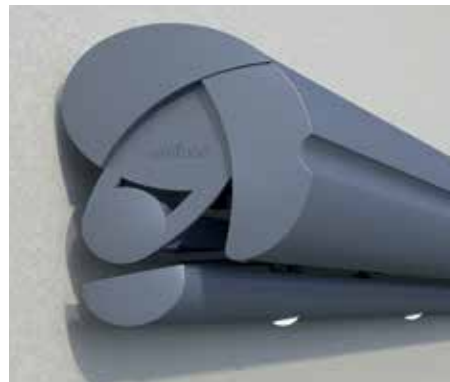



Blends seamlessly into the facade

3 cassette variants. | Face + Recess + Rafter

Housing highly protects fabric + mechanism



# Semina

# Topas II + Topas II LED

TOPAS | COMPACT + AFFORDABLE



Small, compact and versatile entry model. Topas Awnings are available without a hood, especially suited for installation under balconies or protruding roofs, or with a ready-mounted Aluminium hood. This uncomplicated technology makes it stable and wind-resistant. When open, the Awning stands out for its extreme flexibility.

## Specifications:

### Awning Profile Dimensions [WxH]:

220mm x 210mm [ w.Hood ] + 210mm x 180mm [ w/o.Hood ]

### Maximum Width:

6.5m [ 1 sect. 2 arms ] + 7m [ 1 sect. 3 arms ] + 12m [ 2 sect. 4 arms ]

### Maximum Projection:

Up to 4m

### Wind Rating:

Beaufort I 4/5

### Pitch Angle:

5° -40°

### Colours:

Frame: 56 frame colours, + 210 powder coat colours.

### Standard Fabric:

171 Acrylic + Polyester solution dyed fabrics including 28 sustainable options.

### Motorisation:

Highly suitable. **somfy.**





High quality + affordability.  
Compact entry-level model.  
Precision German built quality.



# Topas II

# Plaza Viva + VertiTex II

## THE ULTIMATE PATIO ROOF + OUTDOOR ROLLER COMBINATION

### Plaza Viva

Plaza Viva is an incredibly wind-resistant Retractable Patio Roof that can provide up to 6m x 5m width and projection. It is ideal for exteriors with insufficient load-bearing capacity for a Folding Arm Awning. Technical innovations such as the optional adjustable Telescopic Post, the OptiStretch version, integrated LED Lights and gear handle operated Valance Plus leave almost nothing to be desired.

### Plaza Viva + VertiTex II

The Plaza Viva + VertiTex II Exterior Roller Blind provides exceptional sun, rain, wind, and glare protection, ensuring high levels of privacy. The slimline Patio Roof complements the Roller's minimal cassette sizes, giving it a seamless and architectural appearance. Built using state-of-the-art technology and the highest quality German materials and componentry.

### Specifications:

#### Plaza Viva + Plaza Viva LED

#### Awning Style:

Textile Pergola Awning | Plaza Viva cassette protects the textile and mechanism from the elements.

#### Maximum Width

6m | Multiple systems may also be joined side by side.

#### Maximum Projection:

5m

#### Rain class 2 is met:

With Plaza Viva w. fixed posts from a pitch of 14°  
With Plaza Viva w. telescopic posts from a pitch of 4°  
(Valance Plus option 5°) with fully lowered post.

#### VertiTex II

See VertiTex II specifications.

### Options:

#### Valance Plus:

Height: 1m + 1.5m + 2.1m.  
Option unavailable with VertiTex II combination.

#### Tempura Heater:

Efficiently reaches full radiant temperature in 2 seconds.  
Energy efficient running costs.

#### OptiStretch:

Eliminate sag + light gaps + superior water protection.

#### Adjustable Telescopic Post:

Standard Plaza Viva unit has fixed posts. Adjustable Telescopic post option replaces one fixed post to enable one side to be lowered to quickly drain water. Option unavailable with VertiTex II combination.

#### Wind Rating:

Beaufort | 6 + Wind Resistance Class 3.

#### Pitch Angle:

4° -25°

#### Colours:

Frame: 56 frame colours, + 210 powder coat colours.

#### Standard Fabric:

71 Acrylic + Polyester solution dyed fabrics including 28 sustainable options.

#### Motorisation:

Highly suitable. **somfy.**





Suitable for shading large areas.

Innovative Telescopic Post system.

Seamless integration of 2 award winning designs.

# Plaza Viva + VertiTex II





# Pergotex II

## RETRACTABLE TEXTILE PATIO ROOF SYSTEM

Enjoy the outdoors whatever the weather. Full protection from wind, rain and UV-rays whilst enjoying the fresh air. Integrated high power LED Spotlights extend evening hours. VertiTex II Side Blinds provide lateral weather protection on all 3 sides. Spanning a massive 7m between front posts, including gutters and down pipes, this fully waterproof Retractable Roof stands apart from the crowd.

Pergotex II is an exceptional roof system having been awarded Europe's 2016 Red Dot Award for design, innovation excellence and build quality.

### Specifications:

#### Maximum Width:

7m

Modular so multiple systems can be joined to allow for greater widths.

#### Maximum Projection:

6.5m

#### Fabrics + Frame Colours:

PVC-coated pergola fabrics in Blockout and Light Filtering as well as 56 standard frame colours to choose from.

#### Wind Rating:

Beaufort I 11 + Wind Resistance Class 6.

#### Pitch Angle:

Sun Solution 0° - 8° | Rain Solution - From 8° - 25°

#### Colours:

Frame: 56 frame colours, + 210 powder coat colours.

#### Standard Fabric:

7 Translucent + 3 Blockout

#### Motorisation:

Highly suitable. **somfy.**



reddot award 2016  
best of the best





High end all weather protection.

Cutting edge award winning design.

Integrated high power LED Lights.



# Pergotex II

# WGM TOP

OVER ROOF AWNING SYSTEM. SUITS ANY PATIO OR CONSERVATORY

## Versatile Slimline Sun Protection

An elegant state-of-the-art design that's suitable for almost any patio or conservatory roof, even retro-fitted. Perfect for a fully glazed conservatory, wooden pergola or any other verandah. WGM Top provides sun protection for roofs up to 6.5m wide. Our multi system units can span much wider outdoor areas.

At Weinor, design is as important as function. WGM Top complements all conservatory & patio roofs with great style perfectly integrating into the facade's overall look on most architectural styles. It's clean, slimline profiles show no visible fixings. Suitable for most residential or commercial installations.

Together with a huge selection of frame and fabric colours, the optional OptiStretch technology will secure the fabric into the side channels providing superior wind resistance and eliminating light gaps.

## Specifications:

### WGM Top

#### Awning Style:

Over Roof Conservatory Awning | Fully protected textile and mechanism.

#### Maximum Width:

6.5m | Multiple sections may be butted together.

#### Maximum Projection:

6m

### Option

#### Operation:

Top Down or Bottom Up.

#### OptiStretch:

Eliminate sag + light gaps.

#### Wind Rating:

Beaufort | 6 + Wind Resistance Class 3.

#### Pitch Angle:

0° - 45°

14° - 45° Suitable for light rain

Rain sensor recommended

#### Max. Fabric:

36m<sup>2</sup> ( Additional -refer Tech Manual )

#### Colours:

Frame: 56 frame colours, +  
210 powder coat colours.

#### Standard Fabric:

171 Acrylic + Polyester solution dyed fabrics  
including 28 sustainable options.

#### Motorisation:

Highly suitable. **somfy.**





Elegant design with no visible fixings.  
State-of-the-art OptiStretch technology.  
German precision and quality.



# WGM TOP

# Sottezza Originale LED

## ROUND CONSERVATORY AWNINGS | UNDERMOUNTED

The Sottezza Originale combines classic elegance with advanced functionality, making it a versatile choice for various architectural styles. Its timeless round design enhances the sophistication of any outdoor area, while maintaining compatibility with most patio roof types. Built with an aluminium rope drum for strength and a flat retaining bracket for easy installation and maintenance, the Sottezza Originale ensures long-lasting performance. The integrated LED Spotlights in the cassette not only illuminate the space but also enhance its overall aesthetic.

The Originale features the OptiStretch system to avoid fabric sagging, a trusted rope tensioning system for precise fabric placement, and a new flush front profile to reduce light gaps. These elements work together to offer a refined and durable shading solution that blends seamlessly with traditional outdoor designs.

### Specifications:

#### Installation Under Glass

#### Cassette Dimensions [WxH]:

318mm x 150mm

#### Maximum Width:

6m

#### Maximum Projection:

5m

#### Max. Fabric m<sup>2</sup>

Stretch | 24m<sup>2</sup> Opti | 30m<sup>2</sup>

#### Pitch Angle:

3° - 45°

#### Options

Stretch | OptiStretch | Tempura Infrared Heating

#### Colours:

Frame: 56 frame colours, + 210 powder coat colours.

#### Standard Fabric:

171 Acrylic + Polyester solution dyed fabrics including 28 sustainable options.

#### Motorisation:

Highly suitable. **somfy.**



Honoured  
2018:



The Chicago Athenaeum  
Museum of Architecture  
and Design



Undermount conservatory shading.

Integrated LED lighting in the cassette.

OptiStretch taut fabric technology.



# Sottezza Originale

# Sottezza Pure LED

## CUBIC CONSERVATORY AWNINGS | UNDERMOUNTED

The Sottezza Pure is a state-of-the-art Conservatory Roof Awning designed for modern outdoor spaces. Featuring a sleek cubic design, it seamlessly integrates with nearly all rectangular patio roofs, regardless of the material. Like the Originale, this model boasts an aluminium rope drum for exceptional durability and a custom-designed flat retaining bracket for straightforward installation and maintenance. Enhanced by integrated LED Spotlights within the cassette, the Sottezza Pure adds both aesthetic appeal and functionality to any setting.

Key features include the OptiStretch system to prevent hanging fabric edges, a precise rope tensioning system for accurate fabric positioning, and a new flush front profile to minimise light gaps. These cutting-edge technologies ensure a stylish, reliable, and efficient shading solution.

### Specifications:

#### Installation Under Glass

#### Cassette Dimensions [WxH]:

318mm x 150mm

#### Maximum Width:

6m

#### Maximum Projection:

5m

#### Max. Fabric m<sup>2</sup>

Stretch | 24m<sup>2</sup> Opti | 30m<sup>2</sup>

#### Pitch Angle:

0° - 45°

#### Options

OptiStretch | Tempura Infrared Heating

#### Colours:

Frame: 56 frame colours, + 210 powder coat colours.

#### Standard Fabric:

171 Acrylic + Polyester solution dyed fabrics including 28 sustainable options.

#### Motorisation:

Highly suitable. **somfy.**



**weinor**





Undermount conservatory shading.

Stunning profile. Minimal cubic designer styling.

Integrated LED lighting in the cassette.



# Sottezza Pure

# Paravento

SIDE SCREEN PANELS | PRIVACY + WIND PROTECTION

Enjoy your outdoor living with complete privacy using the Paravento Side Screen. This stylish and practical solution retracts into an elegant cassette when not in use. It offers maximum protection from neighbours, prying eyes, and unpleasant winds, making it the perfect complement to Awnings and textile Patio Roofs.

**Specifications:** Height to 2.5m | Width to 4m | Max. fabric M: 8 m<sup>2</sup>



# Ambience

CUSTOM LED LIGHTING + INSTANT WARMTH

LED + LED RGB Strip

## LED Light Bar:

Enhance your patio and extend outdoor living with a Weinor LED Light Bar. Compatible with a Weinor Awning or installed separately, it provides beautiful ambient lighting. Control it via hard-wired switch or remote. With a lifespan of about 30,000 hours, it saves energy and resources.

## LED RGB Strip:

The Weinor RGB LED Light Strip offers versatile alfresco lighting with up to 48 colours and 3 whites. Weatherproof and installable almost anywhere on your patio, it creates striking light effects and moods. Customise your outdoor lighting for different occasions and enjoy a unique outdoor experience.



# Tempura + Tempura Quadra

Weinor's high-tech infrared heaters let you enjoy your outdoor deck or patio for more evening hours and months of the year. With energy-saving technology, they reach full radiant temperature in just 2 seconds, eliminating any wait for warmth.

The award-winning Tempura Quadra features advanced radiation technology, filtering up to 99% of visible light and significantly reducing glare. The heaters can be controlled via a wall switch or controlled and dimmed with a Somfy remote.



5  
Years Warranty



Excellent privacy + wind protection.

LED energy saving technology.

Tempura heating system. Instant heat.

# Paravento

# Weinor My Collections 2 | Ranges.

THE WORLD'S FINEST SELECTION OF PREMIUM QUALITY EXTERIOR DESIGNER FABRICS.

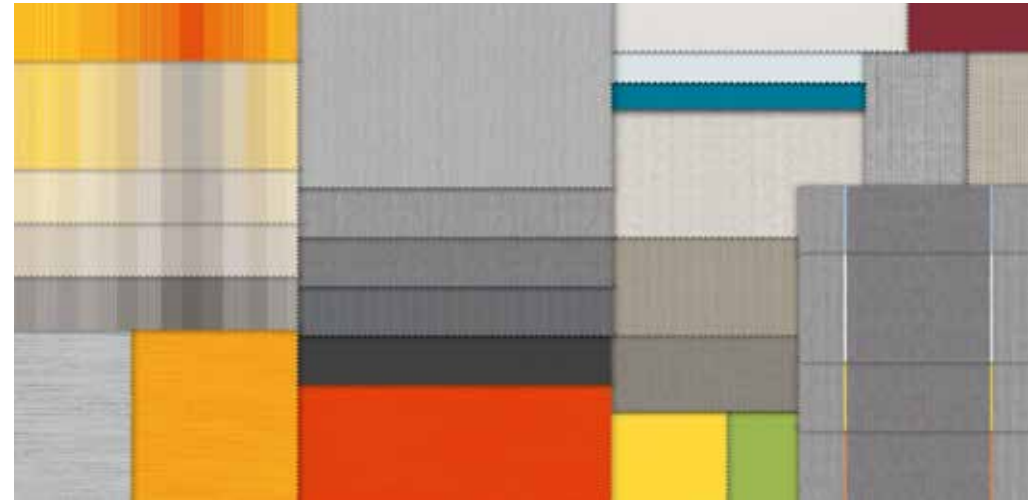

## My Collection 2 | Premium designer colour ranges.

There are 171 exquisite Awning fabrics in My Collection 2, featuring the latest structures and colours. With this collection, Weinor has embraced the growing trend of transforming patios into sophisticated outdoor living spaces. With premium acrylic and polyester fabrics, Weinor is eagerly embracing this challenge by offering high-quality outdoor textiles that meet elevated aesthetic standards.

## Modern Basics Blue | Sustainable PET Recycled range.

These Awning fabrics are produced sustainably. Here, upcycling means approx. 60 % less energy consumption and approx. 45 % less CO2 emissions through PET recycling + approx. 90 % less water consumption thanks to spinneret dyeing. For us it means taking responsibility.



# Modern Basics Blue®

AWARD WINNING PET RECYCLED + SUSTAINABLE EXTERIOR FABRICS.

Exclusive range of premium Awning fabrics.

Unique colour grouped designer collections.

Award winning sustainable PET recycled range.

# Exclusive

# Weinor Exclusive Fabric Ranges

THE WORLD'S FINEST SELECTION OF QUALITY EXTERIOR FABRICS. 143 STUNNING NEW COLOURS & PATTERNS.

## Weinor Fabric Qualities

Our colour brilliance from Solution Dyeing

The manufacturing process determines whether a fabric keeps its brilliant colour for many years to come. Weinor's fabrics are solution dyed. This means that the colour pigment is stored in the fibres during the spinning process. They are then spun into a yarn. The finished yarn is therefore fully saturated with dye (carrot). Weinor's acrylic fabrics have been on the market for decades and are the best possible proof that colours can remain brilliant for a very long time.



The traditional method is to spin the yarn first and then dye it. We call this yarn/piece dyeing (radishes). With this process, bleaching of the colour cannot be ruled out. Weinor fabrics stand out from products made by other manufacturers where only the finished yarn is dyed. Weinor fabrics ensure superior colour fastness.

The woven fabrics that we engineer meet stringent quality requirements and undergo extensive laboratory testing during the production process. Using recognised measurement methods, the grammage, maximum tensile strength, maximum tension force, tear propagation force, water pressure resistance, hydrophobicity, light fastness, weathering fastness, solar energy performance and other properties are subjected to rigid testing.

## Fabric Certifications

Tried & tested certified quality



### OEKO-TEX

Certified in accordance with OEKO-TEX standard 100 and comply with REACH, the European chemicals directive.



### UPF 50+

Weinor fabric's maximum value of UPF 50+ offer the best possible UV radiation protection.



### Teflon Extreme

Dirt-repellance impregnation of fabric with Teflon woven tissue protection and nano technology.

## Weinor Awning Fabrics

My Collections 2 + Modern Basics Blue® | Sustainable



My Collection 2 features an extensive range of 171 awning fabrics combining optimised designs from previous collections with groundbreaking weaves & patterns, including a variety of tried and tested classics, along with 12 patterns exclusive to Weinor. The Modern Basics Blue® range is a highly innovative & sustainable recycled PET fabric.

Weinor fabrics are made from polyester or acrylic. High-quality pigments are stored in each individual fibre. The result; especially good colour fastness and high UV resistance. Teflon fabric coating and state-of-the-art nano technology, ensures the surface is resistant to oil, water, dirt and prevents rot.

### Suitability:

- Folding Arm Awnings** | Open | Semi | Full Cassette
- WGM Top** | Over Roof | Conservatory Awnings
- Sozzezza II Originale + Pure** | Undermount
- Plaza Viva** | Retractable Roof
- VertiTex II Exterior Rollers** | Cable





## Weinor Vertical Sun Fabrics Screens by Weinor



4 perfect privacy and sun protections for windows, patios and balconies. Four high quality fabrics.

### STARSCREEN

#### Textile woven fabric for a homely atmosphere

This spinneret dyed polyester fabric has a very natural textile look and feel. Its open weave increases the light transmission. This ensures an extremely homely character. A superb woven fabric.

#### Suitability:

**VertiTex Exterior Rollers** | Cable | Channel | Zip  
**Valance Plus**

### FIBERGLASS SCREEN

#### Robust fabric for vertical sun protection

The fabric is made of coated fibreglass yarns and is therefore extremely durable and easy to keep clean.

#### Suitability:

**VertiTex Exterior Rollers** | Cable | Channel | Zip  
**Valance Plus**

### SOLTIS 86 + SOLTIS 92

#### Ventilated sun protection

The Soltis® high-tech fabric is extremely air-permeable thanks to its many micro-pores. When used on vertical awnings, it therefore provides for a healthy climate. Soltis® reflects up to 97 percent of all solar rays and therefore provides perfect sun protection. The Soltis® qualities differ from each other in terms of their structure and size, as well as their pore configuration – thus allowing for a higher or lower amount of UV, light and air permeability.

#### Suitability:

**VertiTex Exterior Rollers** | Cable | Channel  
**Folding Arm Awnings** | To 2400mm Projection  
**Valance Plus**  
**WGM Top** | Over Roof | Conservatory Awnings  
**Sottezza II Originale + Pure** | Undermount  
**Paravento** | Side Panel Blinds

### PERGONA

#### Pergona Classic

The Weinor Pergona Classic PVC-coated fabric guides rainwater away reliably. These fabrics give a blackout effect and are therefore suitable for effective shading. Dirty marks cannot be seen from underneath either.

#### Pergona Translucent

The special feature of Pergona Translucent is its high light transmission of up to 21 %. The support fabric allows natural light through and provides optimal protection against rain and UV rays. The fabric is extremely hard-wearing, waterproof and light transmitting at the same time.

#### Suitability:

**Pergotex II** | Only



# Weinor Innovation Excellence

AWARD WINNING DESIGN, INNOVATION & TECHNOLOGIES. CRAFTED WITH GERMAN PRECISION.



## **LongLife Arm** Quiet Operation

Unique LongLife arms with a 10 year guarantee. High quality construction and tested to 100,000 cycles.



## **Wind Lock** Safety Device

Unique Wind Lock technology is designed to stop Awnings lifting up in high wind gusts to eliminate any possible damage above.



## **LED Lighting** 30,000 Hours

Weinor LED's are highly energy efficient, providing 30,000 hours of warm lighting with minimal energy consumption.



## **Weinor OptiFlow® System** Smallest Cassettes

OptiFlow® patented technology enables Weinor to offer very wide blinds in the smallest size cassettes on the market.



## **Integrated Drainage** Water Management

Every Weinor Awning comes with a rain management solution incorporated to channel rain water off to the sides.



## **Zip Technology** Tight Side Capture

Zip technology holds the fabric secure on the side for superior wind resistance & ensures no light gaps.



## **Indent Cable Guide** Unique Weinor Solution

Perfectly suited when end fitting a cable guide is not possible for certain installations.

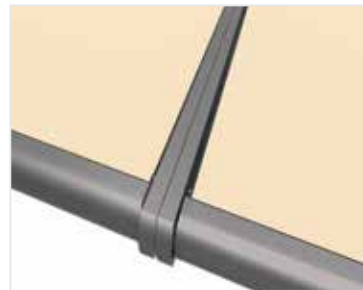

## **Large Commercial Solutions** Large Area Awnings

Our side-by-side systems enable you to cover larger areas, both residential and commercial.

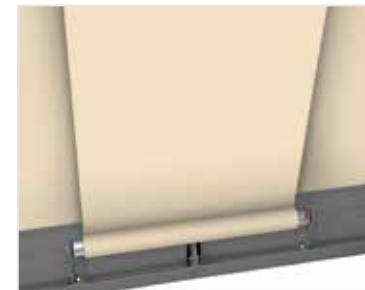

## **Multi Section Units** Large Cover Flexibility

Opal Multisection units allow for easier install of larger Awnings and widths up to 12m wide.



## **Valance Plus** Vertical Screen Integration

Motorised or manual solutions for Vertical Screen's integrated into the Awning's front profile.

A FEW OF THE MANY INNOVATIONS THAT SET WEINOR APART IN THE EXTERIOR RANGE MARKET.



**OptiStretch**  
Superior Wind Resistance

Clamps the fabric on all 4 sides for superior wind stability and to ensure that there are no light or gaps.



**Stretch**  
Cost Effective

Clamps the fabric on 2 sides and offers more economical solutions for Conservatory Awnings.



**Bracket Options**  
Multiple Bracket Solutions

Weinor and PMB can custom design and fabricate bracket solutions for tricky installs including rafter fits or stand-off brackets.



**Custom Brackets**  
All Fixings Covered

Weinor have all bracket options covered from standard wall fix to top fix as well as rafter fit options available.



**Spreader Plates**  
Colour Matched

Weinor offer a standard range of spreader plates for all their Awnings. Custom powder coated to match their standard 56 colours.



**Telescopic Post**  
Rapid Water Removal

Unique Telescopic Post allows for large volumes of water to be easily and quickly drained off to one side. Exclusive to Plaza Viva.



**Design Awards**  
Innovation & Design

Weinor the company and their products are multi-award winners for excellence in Design Innovation and Technology.



**My Collections 2**  
Colours Retain Brilliance

Over 171 Solution Dyed Acrylics and Polyester fabrics to suit any need. Superior colour fastness. High UV resistance.



**Screens by Weinor**  
Perfect For Privacy & Sun

Suitable for VertiTex II, WGM Top or Valance Plus options.



**56 Powdercoat Colours**  
Exceptional Colour Range

Weinor offer the largest standard powdercoat range available on the market with access to over 210 colours.

# Solare Teknica

AWNING + HEADBOX OPTIONS | VERSATILITY. FOUR PRODUCTS IN ONE

Solare Teknica Series has been designed by Australians specifically for the Australian climate, with design, styling, and quality top-of-mind. The modern and contemporary Solare Teknica series is suited to all exterior facades. 4 matching Awning styles allow you to personalise the perfect Awning to suit your external shading requirements. Mix and match the Awning styles whilst still maintaining a common appearance and design on your home.

## Awning Options



**Solare Teknica**  
T1000

**Straight Drop Awning**  
Hold Down Straps

Sleek and simple with a modern aesthetic suitable for balconies or strapping to the floor.



**Solare Teknica**  
T2000

**Straight Drop Awning**  
Cable Guide

The ultimate industrial look which gives you privacy and allows ventilation.



**Solare Teknica**  
T5000 [ Zip ]

**Straight Drop Awning**  
SRS | Side Retention System

Ideal for high wind areas.

Completely enclosing an outside area, with no gaps for dust, dirt & insects to enter.



**Solare Teknica**  
T5500

**Pivot Arm Awning**  
Heavy Duty

Projected off the window allowing air to flow behind.

Windows can be open while Awning is projected.



**Solare Teknica**  
Open Roller

A modern industrial look is offered by exposing the componentry. By eliminating the aluminium headbox profiles, the price is significantly reduced.



# SOLARĒ TEKNICA™

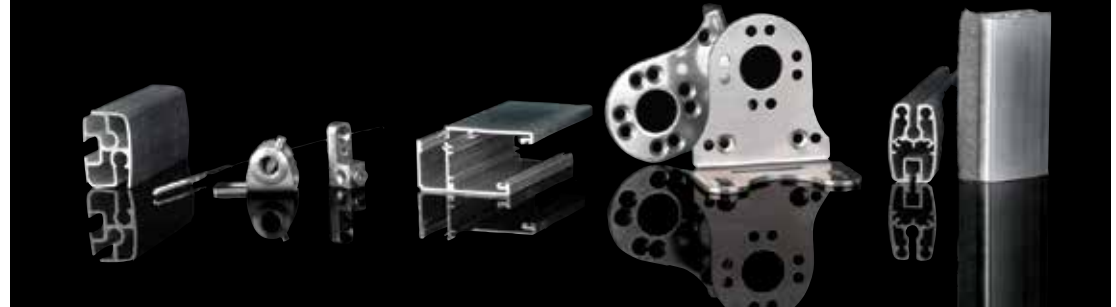

## Solare Teknica Open Headbox

Increase air circulation around the roller minimising heat build up for PVC skins.

(Ideal for Pivot Arm Awning also for Cable Guide & Straight Drop)

## Solare Teknica Closed Headbox

Encapsulates the fabric and protects it from external elements such as rain, UV and fragments keeping the fabric clean and enhances longevity.

## Colours Standard Powdercoat Colours



**Satin Black**  
Like: Night Sky

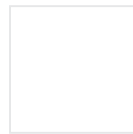

**Satin White**



**Nocturnal**  
Like: Monument



**Classic Cream**



**Silver Pearl**  
Like: Citi Pearl

# Solare Teknica | T1000

## EXTERIOR ROLLER | STRAIGHT DROP

Solare Teknica Series has been designed by Australians specifically for the Australian climate, with design, styling, and quality top-of-mind. The modern and contemporary Solare Teknica series is suited to all exterior buildings both residential and commercial.

The Solare Teknica 1000 Straight Drop provides your home with entry level UV protection and is very simple to use. Sleek and simple with a modern aesthetic, suitable for balconies where you are able to strap the Blind to the railings or down to the ground. This Blind is designed to be either fully up or strapped in the down position.

### -Specifications:

#### Size:

Maximum Width: 5m or, Maximum Drop: 4m – up to max. 15m<sup>2</sup>

#### Style:

Exterior Roller I Straight Drop

#### Best for:

Sun + UV protection, use where channels are not suitable.

#### Suitability:

Windows + Balconies + Alfresco Dining

#### Open Rollers:

Modern industrial look is offered by exposing the components.

Eliminating the aluminium head box profiles, the price is significantly reduced.

Headbox is optional.

#### Fabrics:

Huge collection of Screens and Acrylic Canvas fabrics.

Most fabrics available by request.

#### Powdercoat Colours:

Satin White + Satin Black + Classic Cream + Silver Pearl + Nocturnal

#### Motorisation:

Highly suitable. **somfy**.



**Satin Black**  
Like: Night Sky



**Satin White**



**Nocturnal**  
Like: Monument



**Classic Cream**



**Silver Pearl**  
Like: Citi Pearl



Very affordable entry level system.

Huge selection of screens and fabrics.

Engineered for Australian conditions and independently tested.



# T1000

# Solare Teknica | T2000

## EXTERIOR ROLLER | CABLE GUIDE

Sleek and simple with a modern aesthetic, suitable for most applications, this is our most popular exterior screen Blind. Use with or without a head box, the superior quality stainless steel cable guides allow the Blind to be raised and lowered without the Blind blowing in the breeze. Designed to be either up or down, the optional locking bolts hold the fabric taut and minimises bottom rail movement. Free moving cable guide end caps allow floating in and out of the bottom rail and the Awning operates smoothly without putting pressure on the cable. The T2000 a very versatile Outdoor Roller, that enhances any architectural style.

### Specifications:

#### Size:

Maximum Width: 5m or, Maximum Drop: 4m – up to max. 15m<sup>2</sup>

#### Style:

Exterior Roller | Cable Guide

#### Best for:

Sun + UV protection, use where channels are not suitable.

#### Suitability:

Windows + balconies + alfresco dining.

#### High Quality Cables:

Cables are high tensile 2.5mm 316 grade marine stainless steel, making them perfect for coastal applications.

#### Fabrics:

Huge collection of Screens and Acrylic Canvas fabrics.  
Most fabrics available by request.

#### Colours:

Standard Powdercoat:

Satin White + Satin Black + Classic Cream + Silver Pearl + Nocturnal

#### Motorisation:

Highly suitable. **somfy.**



Satin Black  
Like: Night Sky



Satin White



Nocturnal  
Like: Monument



Classic Cream



Silver Pearl  
Like: Citi Pearl



Quality 316 marine grade stainless cables.

Easily controlled in strong breeze.

Engineered for Australian conditions and independently tested.



# T2000

# Solare Teknica | T5000

## EXTERIOR ROLLER | SIDE RETENTION ZIP

With head box and side channel as standard, the fabric is tensioned by utilising a floating channel, located within the special two piece side channel, eliminating the possibility of fabric "blow outs" or light gaps. As the fabric is held taught between the left and right channels, this system is ideal for enclosing courtyards, patios or balconies; essentially adding an extra room to the home. The Solare Teknica 5000 is a great way to shelter courtyards and other outdoor spaces from wind, insects and UV rays. Hand operation is also available with Lite Rise Spring Balance system that allows you to easily operate by hand.

### Specifications:

#### Size:

Maximum Width: 5m or, Maximum Drop: 4m – up to max. 16m<sup>2</sup>

#### Style:

Exterior Roller I ( SRS ) Side Retention System I Zip System

#### Best for:

More suitable in high wind areas.

Sun + UV protection. Light & heat control. Insect Resistant. Enclosing balcony + creating privacy.

#### Suitability:

Windows + balconies + alfresco dining.

#### Locking Bolts:

The channel end caps essentially push the floating channel up 15mm allowing the locking bolt to insert into the base of the channel.

#### Options:

Lite Rise

#### Fabrics:

Huge collection of Screens and Acrylic Canvas fabrics. Most fabrics available by request.

#### Colours:

Standard Powdercoat:

Satin White + Satin Black + Classic Cream + Silver Pearl + Nocturnal

#### Motorisation:

Highly suitable. **somfy.**



Lite Rise | Balanced Spring allows for easy hand operation



Satin Black  
Like: Night Sky



Satin White



Nocturnal  
Like: Monument



Classic Cream



Silver Pearl  
Like: Citi Pearl

5  
Years Warranty



Excellent high wind stability.

Locking bolts for added security.

No gaps ensure insect free relaxing.



T5000

# Solare Teknica | T5500

PIVOT ARM AWNING | PROVIDES SUPERIOR AIRFLOW

Fabric is projected off the window which allows air to flow behind the Awning. Windows can be open whilst the Awning is projected. A contemporary design ideal for larger windows and by using fixed side rails an extended Awning effect can be achieved with a projection of up to 1500mm. This Awning is a cost effective Awning with superior airflow & features. Option it up with the sliding arms so you can adjust the pitch at the drop of a hat.

## Specifications:

### Size:

Maximum Width: 5m or, Maximum Drop: 3m – up to max. 15m<sup>2</sup>

### Style:

Exterior Awning | Pivot Arm

### Best for:

Stable in High Wind areas.. Excellent air flow + circulation.

### Suitability:

Windows + balconies.

### Heavy Duty Pivot Arm:

The heavy duty spring incorporated in the Pivot Arms provides excellent fabric tension even with awning widths up to 5 metres. The arms are a modern anodised finish & complement the standard Silver Pearl hardware.

### Cassette + Front Rails:

5 std. Powdercoat colours:

Silver Pearl + Classic Cream + Satin White + Satin Black + Nocturnal

### Options:

Sliding Arm rail.

### Fabrics:

Huge collection of Screens and Acrylic Canvas fabrics.

Other fabrics available by request.

### Motorisation:

Highly suitable. **somfy**.

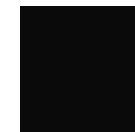

Satin Black  
Like: Night Sky



Satin White



Nocturnal  
Like: Monument



Classic Cream



Silver Pearl  
Like: Citi Pearl

5  
Years Warranty



Allows air to flow behind Awning.

Slim, minimal and uber stylish design.

Cost effective & highly efficient Awning.

15500





# Exterior Shutters

## PREMIUM POWDER COATED ALUMINIUM SHUTTERS

Our premium Exterior Shutter range combines cutting edge engineering with beautiful design. This powdercoated Aluminium Shutter is like no other, providing unprecedented durability, flexibility and strength. They will weather the harshest elements. Elegant and minimalist, this is the most streamlined Shutter in the market. It's two-part frame hides all screws so there are no visible fixings & the internal blade rotation provide the ultimate clean look.

We also offer a cost effective range of Aluminium Shutters that combine beauty, durability and versatility. These Shutters can be ordered to suit most window sizes and will enable you to maximise and utilise your indoor and outdoor spaces.





Ultimate clean minimal look. No visible fixings.

Premium Aluminium with powdercoated finish.

Strong & durable to weather the harshest elements.

# Shutters



# Aluflex® | External Venetians

CONTEMPORARY EXTERNAL METAL VENETIAN BLIND WITH FLAT SLAT.

The Aluflex® External Metal Venetian Blind combines a flat slat profile with a compact stack height, creating a sleek, contemporary finish for residential and commercial buildings.

Designed for cable guide or rail guide mounting, it provides effective glare reduction and enhances indoor comfort. Lightweight and built for wind resistance up to 76km/h, Aluflex® has the most flexible slats in the Griesser range and can bend without crimping.

This ensures long-term durability in exposed conditions. Available in 60mm and 80mm widths, Aluflex® offers a versatile, low-maintenance solution for modern façades



Flat Slat

## Specifications:

### Slats

80 mm flexible flat slats

### Max Sizes:

Area: 20 m<sup>2</sup> | Width: 5000mm | Height: 4500mm

### Guidance:

Galvanised steel cables (PA6 coated) or 25×24 mm low-profile aluminium guide rails.

### Stack:

Approx. 185 mm @ 2.5 m drop

### Ideal For:

Openings where moderate wind performance & minimum stack height are priorities.

### Warranty:

5-year system and motor warranty.

### Colours:

150 Standard Colours

### Options:

60 mm Slat, BiColour, custom colours.

### Operation:

Standard motorisation. **somfy.**

### Daylight Control:



### Darkening:



### Wind Resistance:



21 m/s ≈ 76 km/h (cable) /

16.7 m/s ≈ 60 km/h (rail).

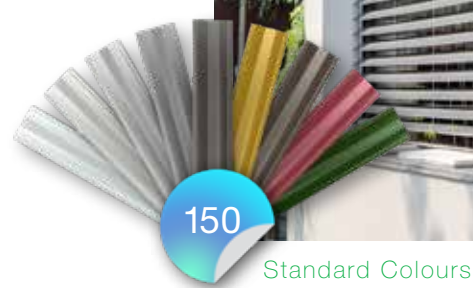

Standard Colours





Smart controls for comfort + efficiency.

Ultra thin blades. Sleek modern look.

BiColour. Perfect match inside + out.

# Aluflex®

# Solomatic® II | External Venetians

EXTERNAL METAL VENETIAN BLIND WITH ROLLED EDGE SLAT DESIGN



The Solomatic® II External Venetian Blind combines a rolled edge slat design with smooth, reliable operation. Each slat is directly linked to adjustable Kevlar cords for precise movement and durability. Available in 70mm and 80mm widths, it suits both new builds (Solomatic® II 80) and retrofits (Solomatic® II 70). With wind resistance up to 92 km/h, it offers a versatile, high-performance shading solution.

Choose between the premium enclosed Solomatic® II System or the cost-effective Solomatic® II L Fix, available with box or cover headbox options for seamless architectural integration



Double Rolled Flat Slat

## Specifications:

### Slats

80 mm double-rolled flat slat with reinforcing bead (higher torsional rigidity).

### Max Sizes:

Area: 15 m<sup>2</sup> | Width: 4500mm | Height: 4500mm

### Guidance:

Galvanised steel cables (PA6 coated) or 25×24 mm low-profile aluminium guide rails.

### Stack:

Approx. 245 mm @ 2.5 m drop

### Ideal For:

All applications. Our most popular model for strength & durability

### Warranty:

5-year system and motor warranty.

### Colours:

150 Standard Colours

### Options:

70 mm Slat, ProtectPLUS, BiColour, custom colours

### Operation:

Standard motorisation. **somfy.**

### Daylight Control:



### Darkening:



### Wind Resistance:



25.6 m/s ≈ 92 km/h (rail)

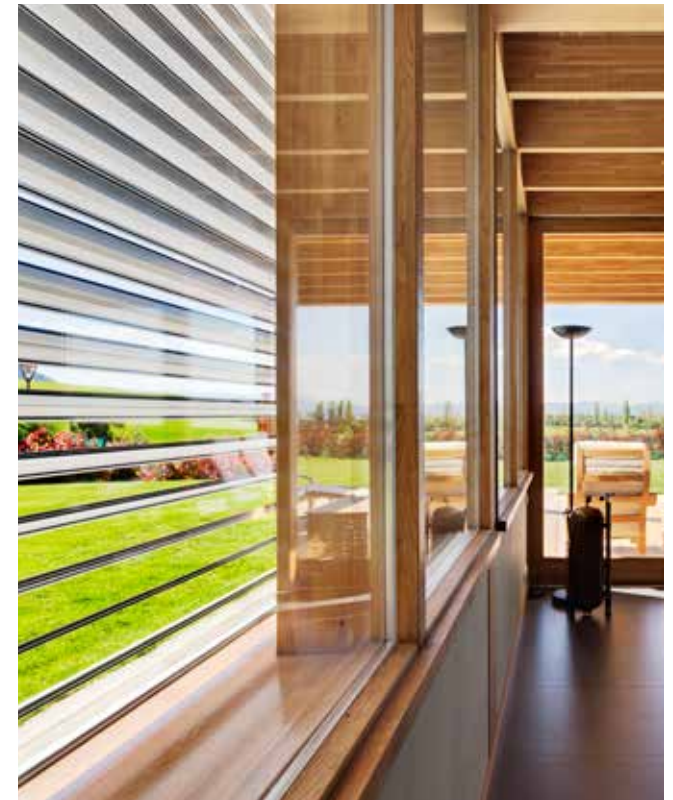

Standard Colours



BiColour. 2 Tone. Inside & out.

150 Std. Colours + Custom ranges.

ProtectPLUS. Enhanced durability.



# Solomatic II<sup>®</sup>



# Lamisol® III | External Venetians

EXTERNAL METAL VENETIAN BLIND WITH Z-SLAT + MAXIMUM LIGHT CONTROL.

As Griesser's best-selling External Venetian Blind, Lamisol®III combines elegant design with advanced functionality for precise light control. Its Z-shaped slats allow for multiple tilt positions, reducing glare, optimising natural light, and improving indoor comfort. Available in 70mm and 90mm slat widths, Lamisol offers exceptional wind resistance, while the Lamisol Vento model withstands winds up to 120km/h, making it ideal for high-rise and exposed locations.

Whether for commercial buildings or residential spaces, Lamisol delivers quiet operation, effective shading, and a sleek, modern aesthetic.

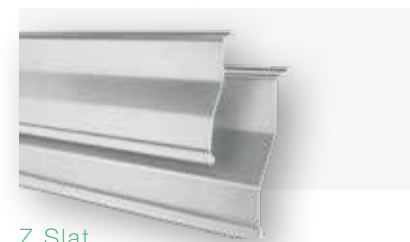

Z Slat

## Specifications:

### Slats

80 mm double-rolled flat slat with reinforcing bead (higher torsional rigidity).

### Max Sizes:

Area: 15 m<sup>2</sup> | Width: 4500mm | Height: 4500mm

### Guidance:

Galvanised steel cables (PA6 coated) or 25x24 mm low-profile aluminium guide rails.

### Stack:

Approx. 245 mm @ 2.5 m drop

### Ideal For:

All applications. Our most popular model for strength & durability

### Warranty:

5-year system and motor warranty.

### Colours:

150 Standard Colours

### Options:

70 mm Slat, ProtectPLUS, BiColour, custom colours

### Operation:

Standard motorisation. **somfy.**

### Daylight Control:



### Darkening:



### Wind Resistance:



25.6 m/s ≈ 92 km/h (rail)



Standard Colours



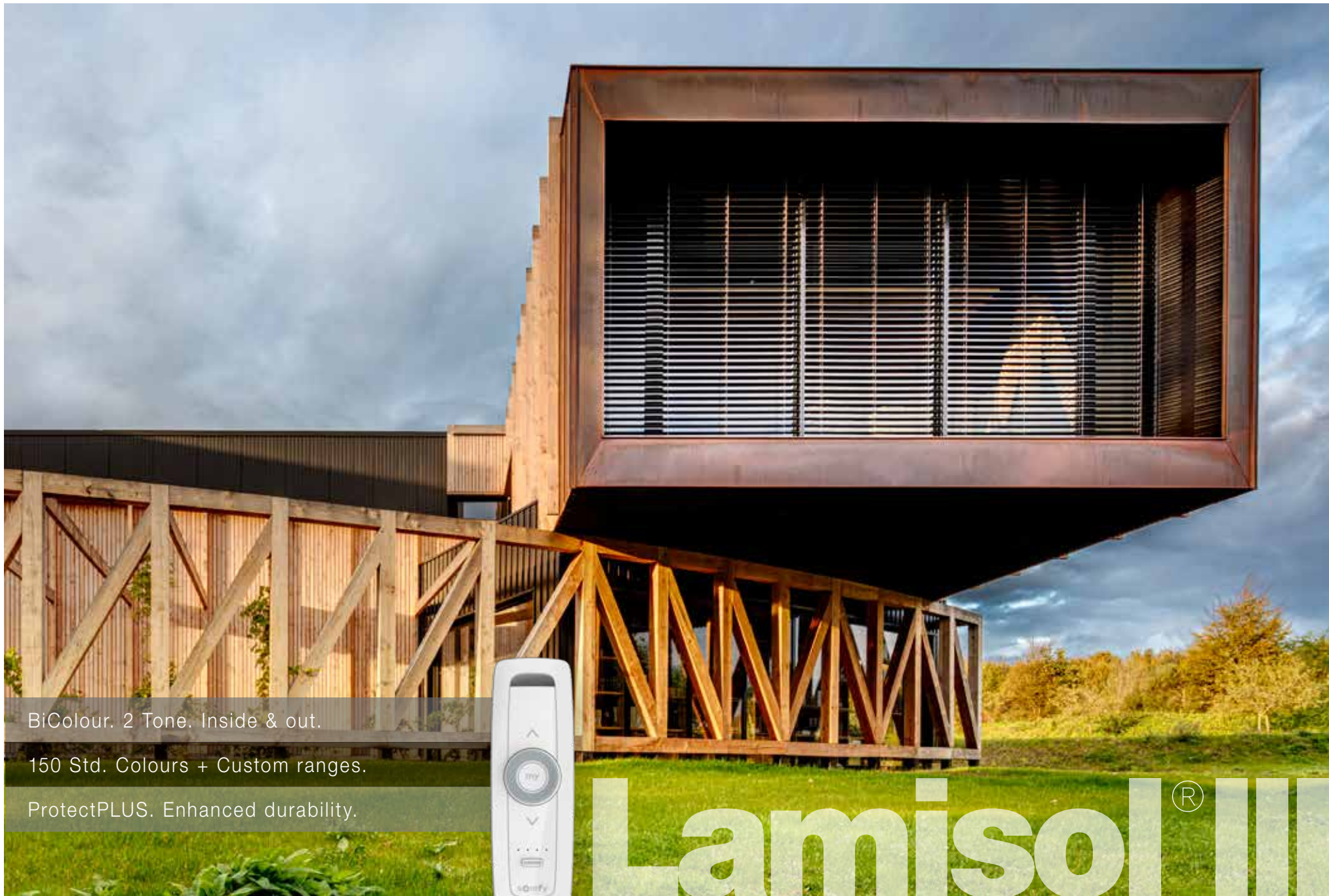

BiColour. 2 Tone. Inside & out.

150 Std. Colours + Custom ranges.

ProtectPLUS. Enhanced durability.



# Lamiso®

# Somfy Home Automation

TOTAL CONTROL WITH YOUR SMARTPHONE AT HOME OR AWAY

## Controlling all your blinds & awnings. Never been simpler.

Easily manage your smart home anywhere or anytime with TaHoma. Use the TaHoma Switch smart control, the TaHoma app, or voice commands.

The TaHoma Switch streamlines control with two customisable scene launcher buttons, simplifying access to your home devices. Tailor each button to create scenes that align with your daily routines. For instance, a quick tap on the "Going Out" scene button as you rush out in the morning.

Compatible with a wide range of Somfy and partner products, including gates, alarms, and heating systems, the TaHoma Switch ensures seamless integration. Partnering with major brands like Phillips and Clipsall, Somfy provides a tailored experience based on your wants.

## Somfy® Controllers



**Situ**  
Remotes  
1, 2 + 5 Channel



**Telis**  
RTS Remote  
16 Channel



**Situ Soliris**  
RTS Remote  
5 Channel



**Situ Variation**  
RTS Remote  
5 Channel



**Ysia**  
Zigbee 3.0  
1+5 Channel



**Ysia Variation**  
Zigbee 3.0  
5 Channel



**Smooove Origin**  
RTS Wall Switches  
1 + 2 + 4 Channel



**Smooove**  
RTS Wall Switches  
Multi Colour Options



**Voice Control**  
Google + Alexa +  
Apple iOS + Android





**TaHoma Switch**

RTS Zigbee 3.0 Smart Control System Smartphone App. +

Voice Control with:

Google + Alexa + Apple iOS + Android



Wi Fi Enabled

TaHoma<sup>®</sup> System



# Somfy Control Inside & Out

VOICE CONTROLLERS + SENSORS FOR EVERY REQUIREMENT

## Controllers + Sensors

Somfy offer a range of Control solutions to meet every automation requirement for indoor & outdoor window shading, protection, and privacy applications for both residential and commercial applications. Somfy's unique range of remote controls offer the combination of cutting edge technology with sleek minimal style – providing the ultimate in convenience and control at the touch of a button.

From our broad range of Somfy Sensors and automation Controllers, you're able to create energy efficient & convenient environments in all of your indoor and outdoor living spaces. As Somfy automation specialists, we can advise you on the most suitable Control solution, from a single channel Remote, to a 6 channel with timer function, through to a 16 channel with personalised scenarios.

### Individual control

Connect your smartphone devices, each with individual personalised control. Centralise all of your RTS motorised products in one place, allowing you to open or close with just a single touch. Schedule opening and closing of every product at the time & date of your choice.

### Remote Access

Maximise the many benefits such as energy saving and privacy, even when you're not at home.

## Somfy® Sensors



**Eolis**  
RTS Wind  
Sensor



**Soliris**  
RTS Sun +  
Wind Sensor



**Eolis 3D**  
RTS Motion  
Sensor



**Ondeis**  
RTS Rain  
Sensor



 zigbee 3.0





**Voice Control**  
Google + Alexa + Apple iOS + Android

Voice + App.

# Automate Motorisation



## RELIABLE AND HIGH PERFORMANCE

The motorisation solutions from Automate are highly reliable and high performing, with quiet operation and seamless integration with Home Automation systems. Their advanced Motor technology is energy-efficient, providing cost savings and sustainability. Automate motorised Blinds are designed to control light and optimise heat to preserve energy and improve interior environments for greater comfort, efficiency and productivity.

Relax in knowing your Blinds motorised with Automate, allow you to connect to your other smart home devices and seamlessly move throughout the day according to scheduling and environmental triggers.

We offer hard wired and wire-free automated solutions.

### Automate® Controllers



**Push**  
ARC Remotes  
5 + 15 Channel



**Pulse 2**  
ARC Control Hub  
Smart Hub + App Controls



**Push**  
Wall Switches  
1 + 2 + 15 Channel

### Automate® Sensors



**Automate®**  
ARC Wind + Rain +  
Sun Sensor

**Sensor**  
ARC Sun Sensor

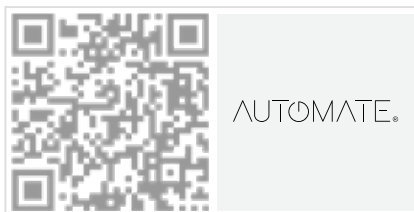

# AUTOMATE™



**Voice Control**  
Google + Alexa + Apple iOS + Android

  
Wi Fi Enabled

Pulse 2

# Move by Silent Gliss

QUIET PERFORMANCE. INTELLIGENT CONTROL.



Silent Gliss has been at the forefront of motorised Curtain and Blind technology for more than 60 years. As pioneers of the first direct-drive Motorised Track, their systems remain the benchmark for whisper-quiet, smooth and reliable operation. Whether integrated into a control system or operated via App, Switch or Remote, Silent Gliss solutions deliver precision and refined performance across both residential and commercial spaces.

With the upgraded 433MHz Receiver, Silent Gliss now offers full bidirectional feedback when paired with the Move by Silent Gliss Hub and App. This provides enhanced responsiveness, real-time position updates and seamless control through iOS and Android. The Move Smart Home Hub centralises all Motorised Curtains and Blinds, allowing you to manage products from anywhere and create personalised scenes that complement your lifestyle. Group Blinds and Curtains by room, automate routines, and connect shading with lighting or audio for a fully integrated experience.

## Move by Silent Gliss | Smart Home Controllers



**Remotes**  
1 + 6 Channel | Black + White

**Wall Switches**  
1 + 6 Channel | White

**433mhz Reciever**  
5600 Curtain Track Motor



# Smart Home



## Hub

**Silent Gliss Move.**  
Compatible with the SG Control N range  
of radio control remotes & wall switches.

# Custom Paint



EXPERT COLOUR MATCH + RANGE FINISHES | FOR DESIGNERS, DECORATORS + ARCHITECTS

We offer custom painted, stained and oiled Timber Venetians as well as custom painted and stained Woven Timber and Chinois Eclectics products. Having our own spray booths allows us to custom paint Roller Blind tubes for a more refined finish on our motorised Roman Blinds.



Colour + Stain + Natural

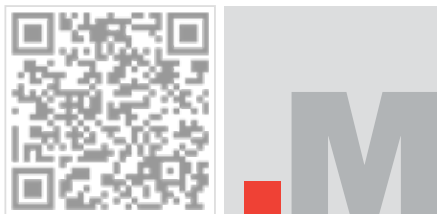



35+ years experience in custom paint + finishes.

Colour matching & custom finishing specialists.

Quality exclusive to Blinds by Peter Meyer.

# Colour

# Our Story

AUSTRALIA'S PREMIUM CUSTOM BLIND MANUFACTURER SINCE 1987



1973

1979

1987

1995



**Blinds**  
by Peter Meyer

## Peter Meyer Furnishings

**1973** | Peter started selling rugs & cane furniture at Paddy's Markets 5 decades ago. Along with his wife Helen, they expanded into specialist interior design & furnishings retailing with high quality design driven stores in Burwood, Enfield, Hurstville & Pymble.

## Le Blinde

**1987** | Peter moved from Interior Design to focus exclusively on quality custom Blind manufacturing. He commenced trading as Le Blinde, exclusively offering Europe's finest French Woven Timber range, together with manufacturing & finishing custom premium Blinds using unique, exotic & exclusive fabrics & weaves sourced worldwide.

## Blinds by Peter Meyer

**1995** | A name change to Blinds by Peter Meyer saw the company grow to become a significant manufacturer of quality custom Blinds & finishings. Also offering an extensive range of sophisticated fabrics and weaves for designers, decorators & architects throughout Australia, NZ & SE Asia.

**1999** | Relocated to a new factory & showroom. In 2024, manufacturing operations now span 3 separate factories in Homebush.

## Virtual Showroom

**2021** | Virtual showroom release showcasing complete ranges in operation.



Custom Quality + Design Excellence.

1999



**Weinor**

2014 | Germany's leading manufacturer of Awnings + Retractable Roofs appoints Blinds by Peter Meyer Australian & NZ distributor.

2014



**Silent Gliss**

2019 | Europe's leading manufacturer of Curtain Tracks & Rods, appoints Blinds by Peter Meyer Australian & NZ manufacturer & distributor.

2019



2021



**Griesser**

2024 | Switzerland's leading manufacturer of precision External Venetian Blinds, appoints Blinds by Peter Meyer Australian & NZ distributor.

2024

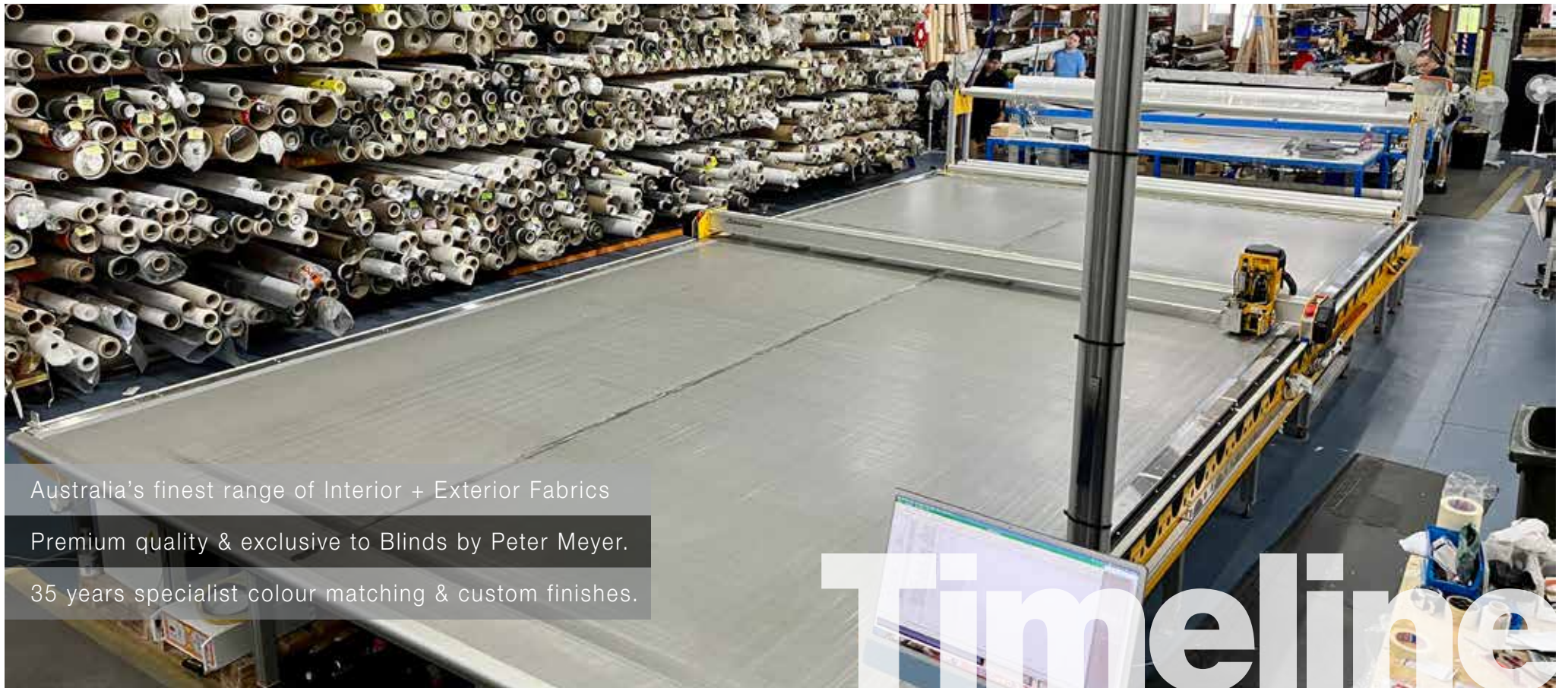

Australia's finest range of Interior + Exterior Fabrics  
Premium quality & exclusive to Blinds by Peter Meyer.  
35 years specialist colour matching & custom finishes.

Timeline

# Interior + Exterior

5  
Years Warranty

Quality Custom Made Blinds + Awnings

Exclusive Interior + Exterior Ranges

Extensive Range of Fabrics + Weaves

Motorisation Specialists + Custom Paint

weinor

GRIESSER

SilentGliss

**MEYER BLINDS**  
QUALITY + DESIGN EXCELLENCE | SINCE 1987