

Web: <https://www.tutudisplay.com.au/>

Mobile&Whatsapp: +61 (0)428 507 916

Email: merry@tutudisplay.com.au

TuTu DISPLAY

JEWELRY STORE FIXTURE & DISPLAY

A Superior Quality Showcase Manufacturer

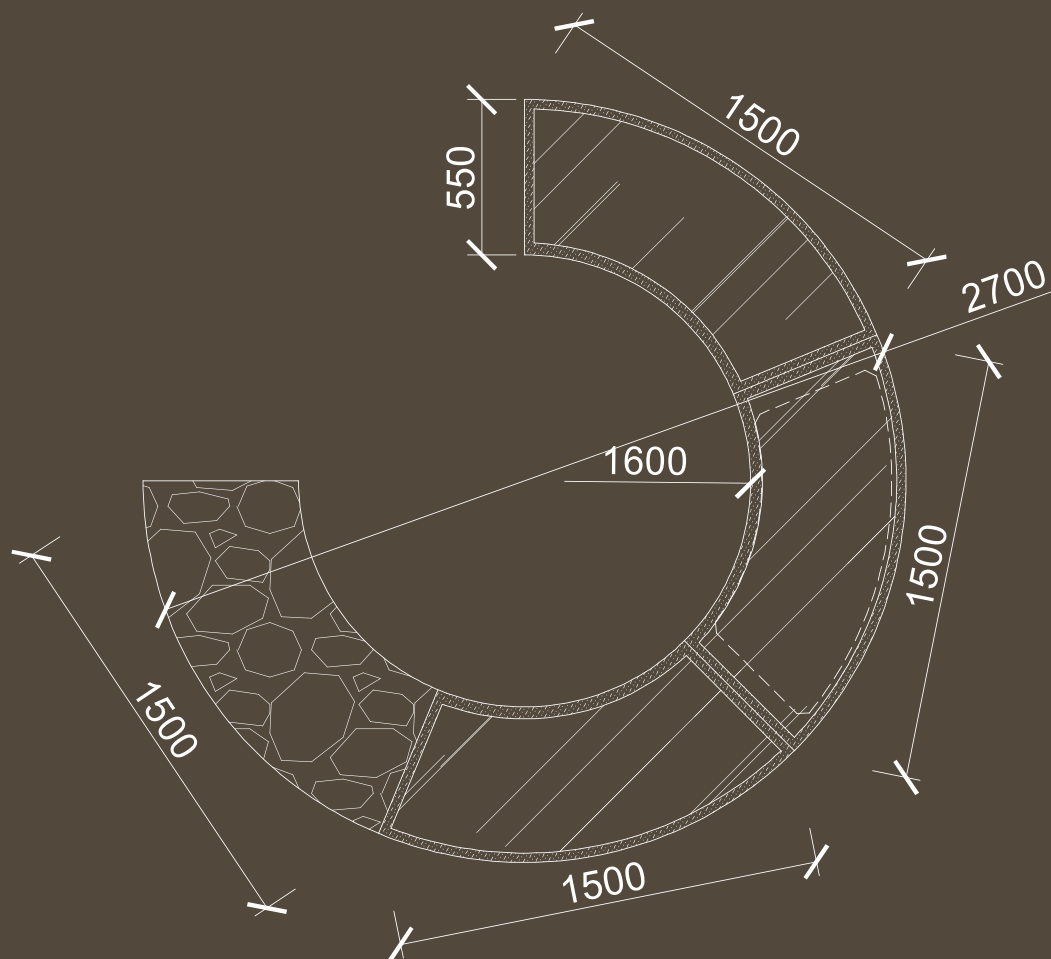

Style - MT-41

W1500mm*D686mm*H1050mm

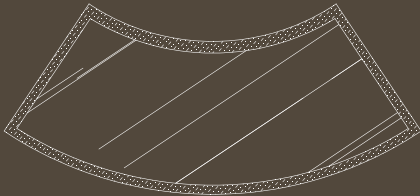

TOP VIEW

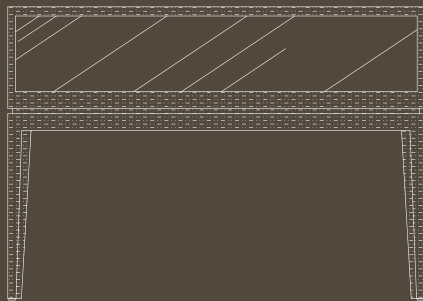
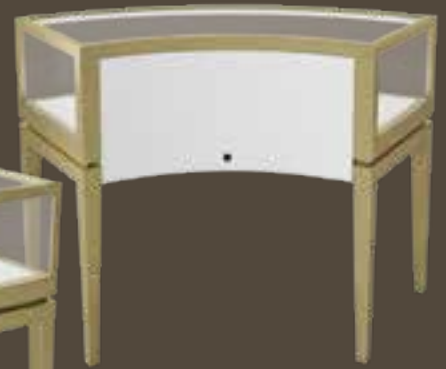

FRONT VIEW

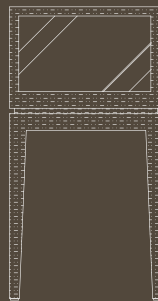

SIDE VIEW

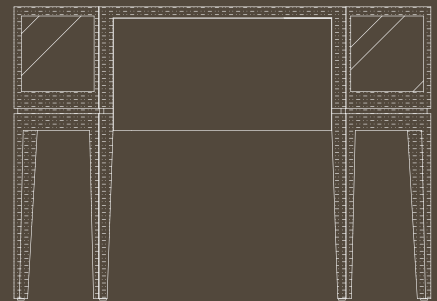

BACK VIEW

Style - MT-42

W1500mm*D686mm*H1050mm

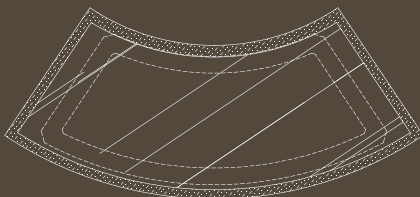

TOP VIEW

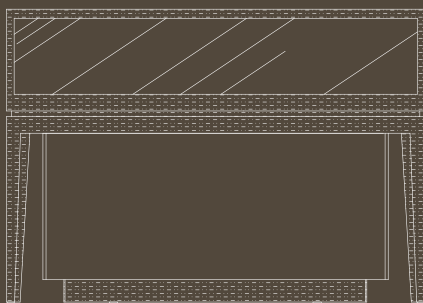
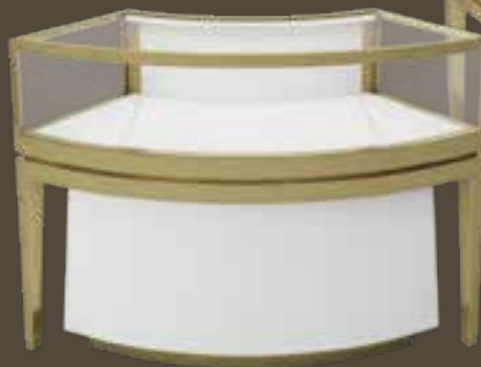

FRONT VIEW

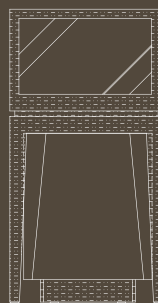

SIDE VIEW

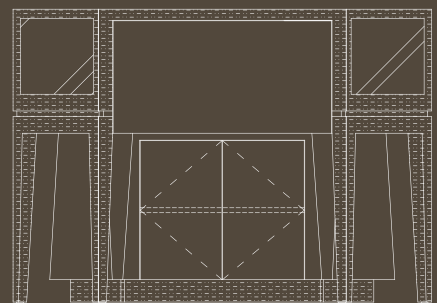

BACK VIEW

Style - TBL-010

W1500*D686*H770mm

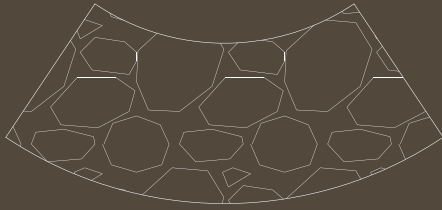

TOP VIEW



FRONT VIEW

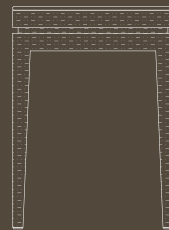

SIDE VIEW



BACK VIEW

Style - MT-26

W1524mm*D610mm*H1067mm

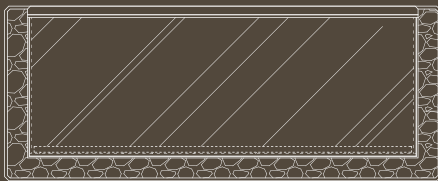

TOP VIEW

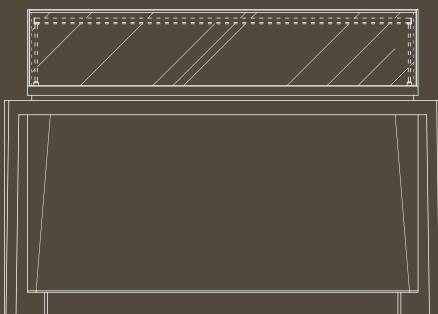

FRONT VIEW



SIDE VIEW

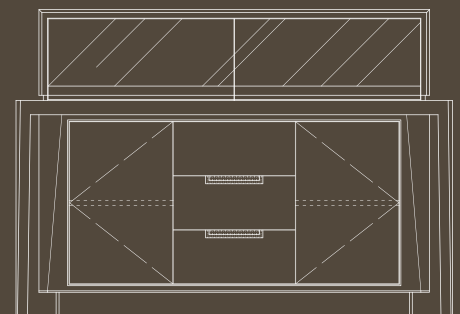

BACK VIEW

Style - MT-43

W1200mm*D550mm*H1050mm

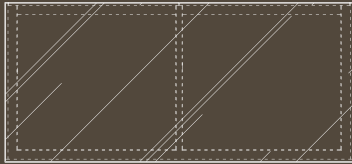

TOP VIEW

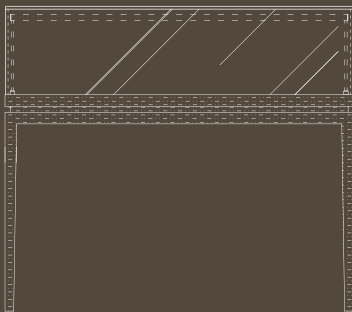
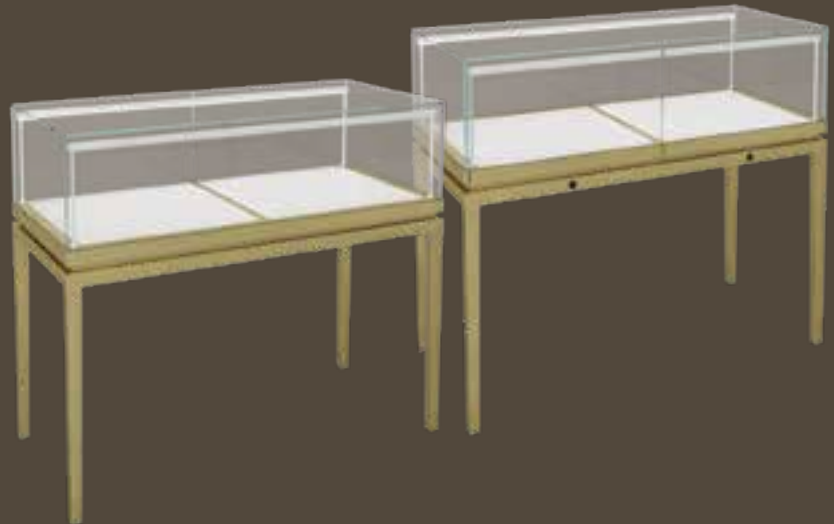

FRONT VIEW

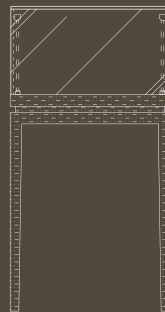

SIDE VIEW

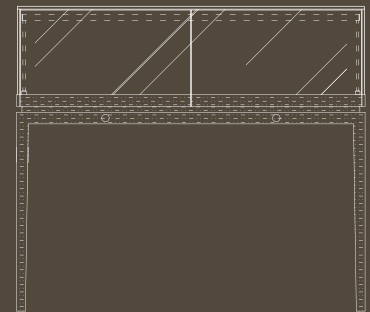

BACK VIEW

Style - MT-43 with Storage

W1200mm*D550mm*H1050mm

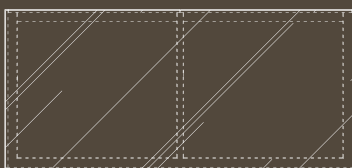

TOP VIEW

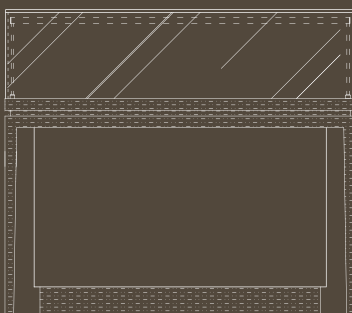

FRONT VIEW

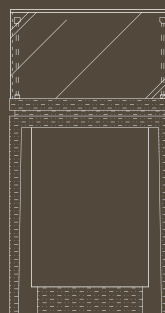

SIDE VIEW

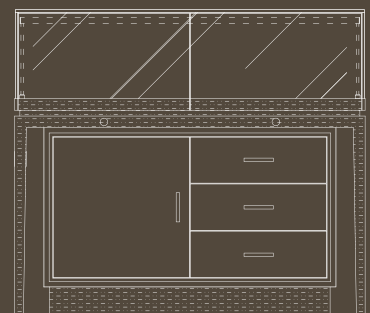

BACK VIEW



Style - MT-32

W1300mm*D550mm*H1050mm

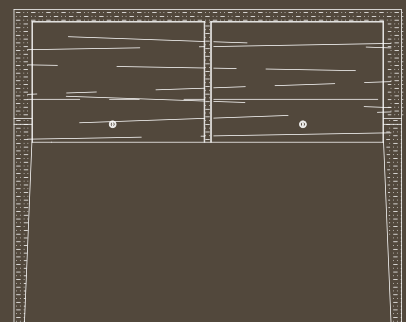
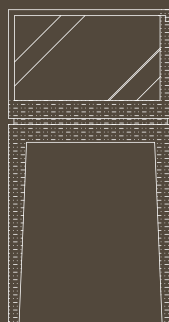
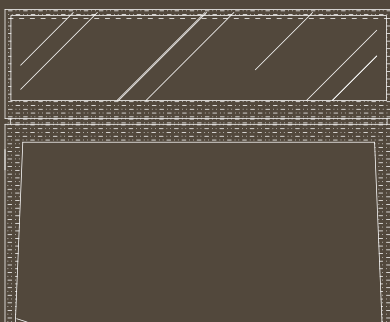
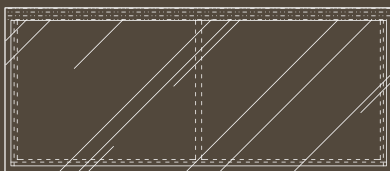

- Brushed Stainless Steel Electroplated Brass
- Timber Veneer Matt Varnish
- Temper Extra-White Glass
- White Micro Fiber
- Lighting CCT 6000K
- Power 40W
- 100~240 Vac





Style - MT-31

-W550mm*D550mm*H1860mm



- Brushed Stainless Steel Electroplated Brass
- Temper Extra-White Glass
- White PU Leather
- Lighting CCT 6000K
- Power 17W
- 100~240 Vac

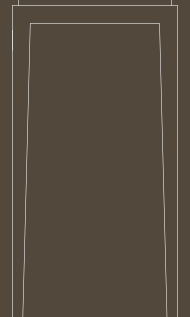
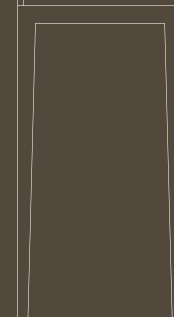
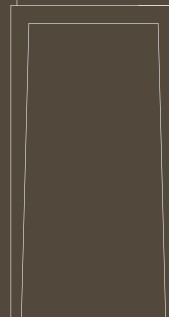
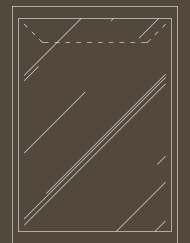
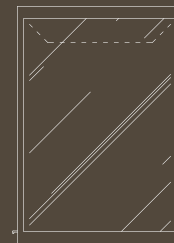
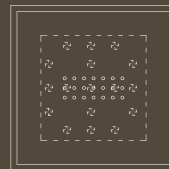



MT-23

W650mm*D350mm*H874mm



MT-22

W650mm*D450mm*H1850mm



MT-26

W1524mm*D610mm*H1067mm



MT-27

W680mm*D610mm*H1470mm



MT-25

W559mm*D559mm*H1473mm



MT-24

W1625mm*D1625mm*H1016mm



MT-37

W1000mm*D600mm*H1080mm



MT-38

W600mm*D600mm*H1680mm



MT-40

W1000mm*D550mm*H1065mm



MT-05

W1450mm*D750mm*H1800mm



MT-15

W1200mm*D550mm*H1100mm



MT-10

W1200mm*D550mm*H1000mm

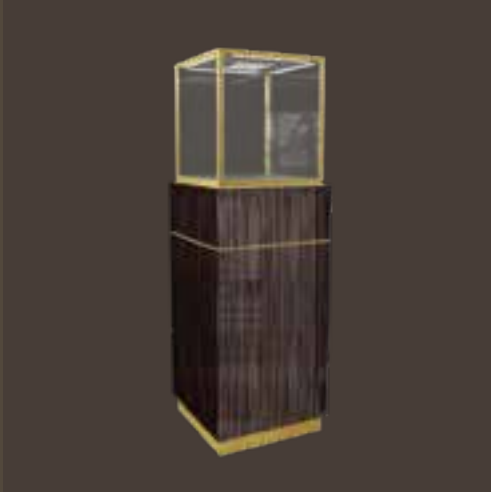

MT-04

W550mm*D550mm*H1677mm



MT-34

φ550mm*H1675mm



S-01

W1000mm*D550mm*H1080mm



S-084

W1200mm*D550mm*H1100mm



S-02

W450mm*D450mm*H1651mm



S-03

W1000mm*D550mm*H2800mm



FA-07

W1000mm*D550mm*H1080mm



S-136

W500mm*D500mm*H1750mm



FA-25

W600mm*D550mm*H1870mm



FA-04

W550mm*D550mm*H1880mm



CA14-009

W1000mm*D500mm*H2000mm



S-120

W550mm*D550mm*H1480mm

HIGHLINE CUSTOM JEWELRY



THE DIAMOND RING CO.



KING'S



KING'S



Harry Edwards Jewelers



Harry Edwards Jewelers



KAY' S FINE JEWELRY



ROSENBERG DIAMONDS & Co.



ZYROS



Sterling



DIAMOND JEWELLERY & WATCHES



PRESTIGE JEWELLERS



GEMELODY INC.



BA GOLD



RIO DIAMOND



ADAMAS



BELLAGIO



THE DIAMOND RING CO.



BIAGO THE JEWELLERS



VOGUE JEWELLERS



HOLDSWORTH BROS JEWELLERS



ROCKHOUNDS OPAL SPECIALISTS



GEM BY CARATI



FRANCESCA





Style - DS307

Material - PU Leather





Style - DS068

Material - PU Leather



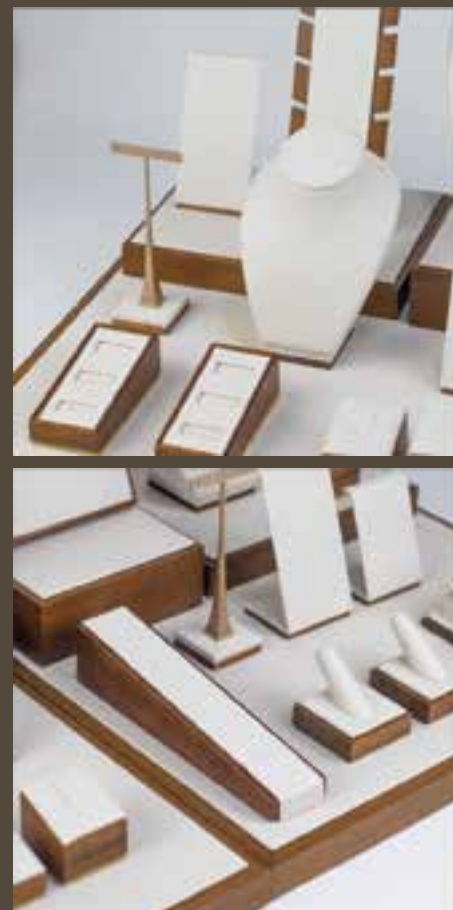

Style - TR0015

Material - Wood / PU Leather





Style - DS059

Material - Metal / Marble / Micro Fiber





Style - DS006

Material - Metal / Acrylic / Micro Fiber





Style - DS305

Material - Metal / Glass / Micro Fiber





Style - DS052

Material - Metal / Acrylic / Micro Fiber





Style - DS037

Material - Metal / Micro Fiber





Style - DS036

Material - Metal / Micro Fiber

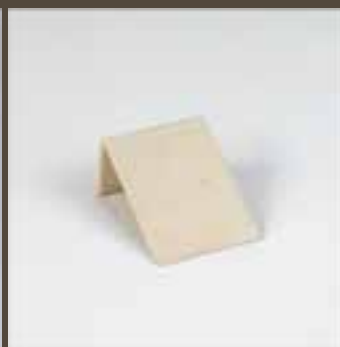



Style - DS054

Material - Metal / Micro Fiber



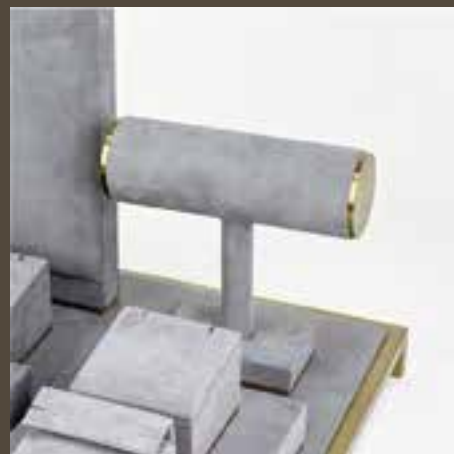

Style - DS303

Material - Metal / Micro Fiber

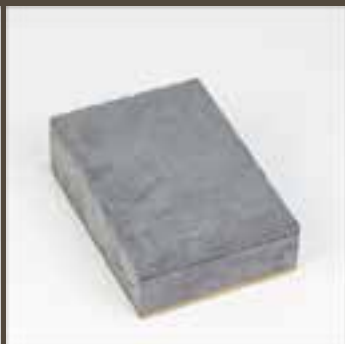



Style - DS034

Material - Micro Fiber





Style - DS040

Material - Micro Fiber





Style - DS029

Material - Metal / Marble / PU Leather





Style - DS042 / DS043 / DS044

Material - PU Leather





Style - DS062

Material - PU Leather





Material - Outer Box & Cover - Paper
Inner - PU Leather



NO. BX068



NO. BX069



NO. BX070



NO. BX071



NO. BX072



NO. BX073



NO. BX074



Material - Outer Box - Paper
Cover & Inner - Micro Fiber



NO. BX077



NO. BX078



NO. BX079



NO. BX099



NO. BX080



NO. BX081



NO. BX082



NO. BX052



Material - Cover - PU Leather
Inner - Micro Fiber



NO. BX053



NO. BX054



NO. BX056



NO. BX055





NO. BX103



Material - Cover - Micro Fiber
Inner - Micro Fiber



NO. BX104



NO. BX105



NO. BX106



NO. BX107





NO. BX089



Material - Outer Box - Paper
Cover - PU Leather
Inner - PU Leather



NO. BX091



NO. BX090



NO. BX092



NO. BX093





Material -
Outer Box - Paper
Cover - Micro Fiber
Inner - Micro Fiber



NO. BX100



NO. BX101



NO. BX102



Tutu DISPLAY

Web: <https://www.tutudisplay.com.au/>

Mobile&Whatsapp: +61 (0)428 507 916

Email: merry@tutudisplay.com.au

Showroom: 104/384 Eastern Valley Way Chatswood NSW 2067

Warehouse: 1/25-27 Redfern Street Wetherill Park, NSW 2164